

## UKFCE207H SNR

Ball bearing units

TYPE: Housing units, Four-bolt flanged housing units, Cast iron housing, Radial insert ball bearing with adapter sleeve, With inner ring extended on both sides, round flanged

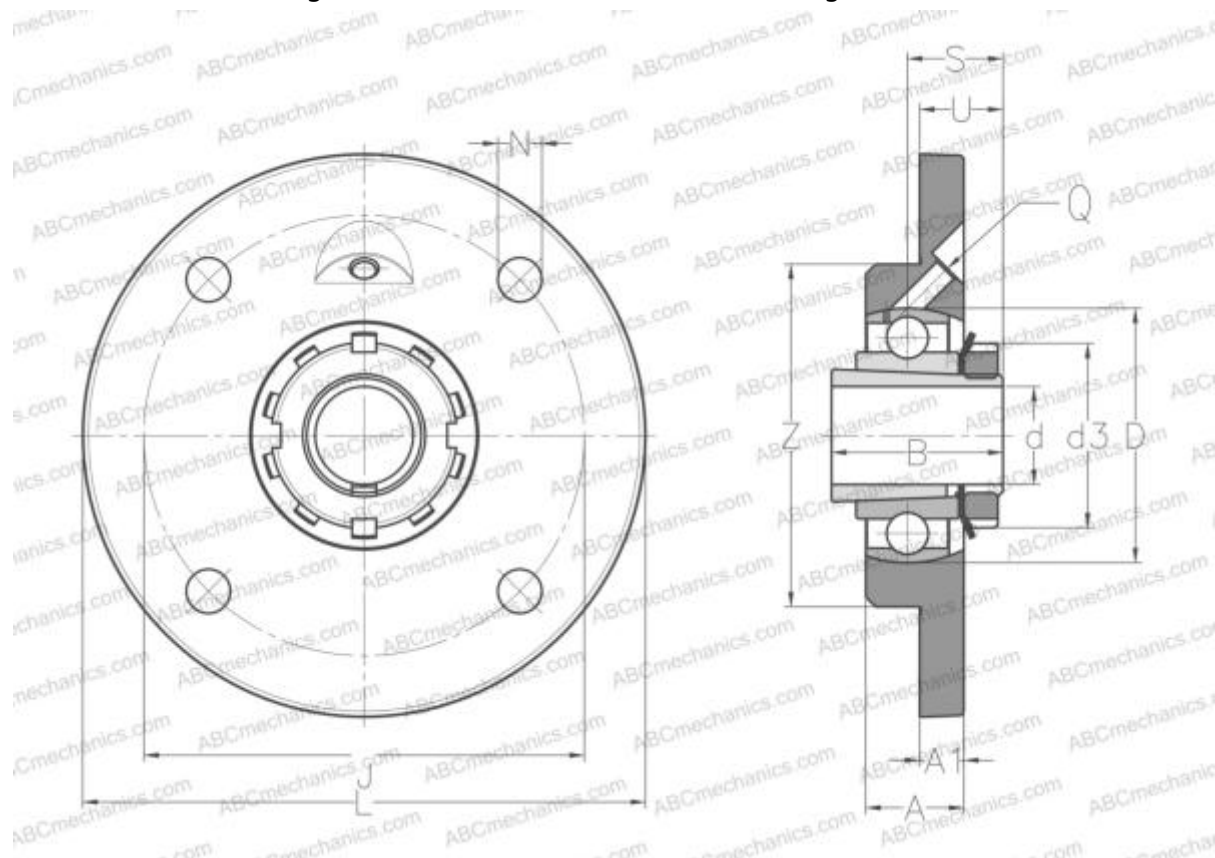

### Technical specification

#### DIMENSIONS, MM

d	30,000
D	72,000
B	43,000
H	135,000
A	21,000
J	110,000
A1	10,000
N	11,500
S	22,500
d3	52,000
U	23,500
Z	90,000
Q	M6x1

Bearing	UK207 +
Housing	FCE207
Adapter sleeve	H2307

#### MANUFACTURER

[SNR](#)

#### INTERCHANGE

ABC	<a href="#">UKFCE207H</a>
-----	---------------------------

#### CALCULATION DATA

Basic dynamic load rating, C	25,700 kN
Basic static load rating, Co	15,200 kN
Operating temperature min	-20 °C
Operating temperature max	110 °C

**WEIGHT, KG** 1,300