

EXFLE203 ABC

Ball bearing units

TYPE: Housing units, Two-bolt flanged housing units, Cast iron housing, Radial insert ball bearing with eccentric locking collar, With inner ring extended on both sides

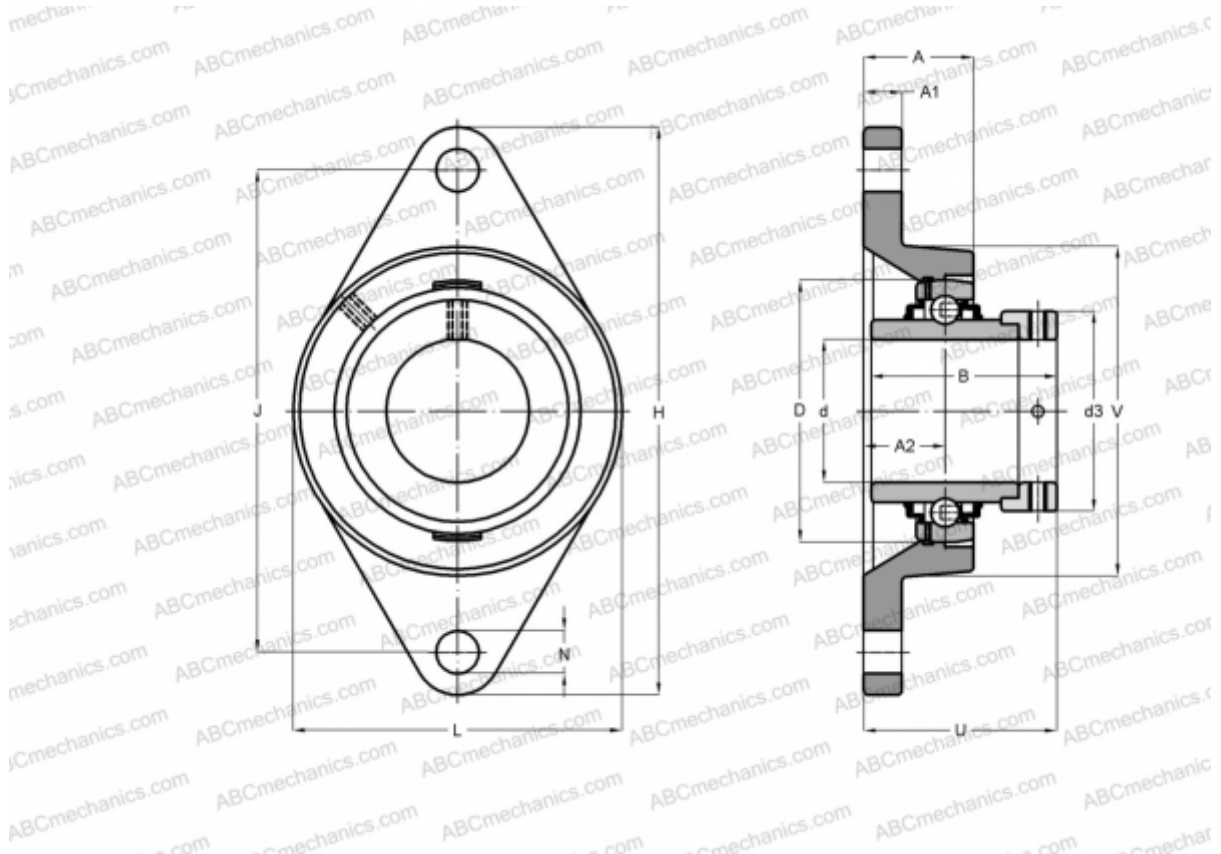

Technical specification

DIMENSIONS, MM

d	17,000
D	47,000
B	43,500
L	61,000
H	112,000
A	30,300
J	90,000
A1	10,000
A2	19,000
N	11,500
S	17,000
d3	33,300
U	37,300
Q	R1/8"

WEIGHT, KG

	0,600
Bearing	EX203
Housing	FLE204

MANUFACTURER

[ABC](#)

INTERCHANGE

SNR	EXFLE203
-----	--------------------------