

ESFL201 SNR

Ball bearing units

TYPE: Housing units, Two-bolt flanged housing units, Cast iron housing, Radial insert ball bearing with eccentric locking collar, With inner ring extended at one side, wide base, massive bearing units

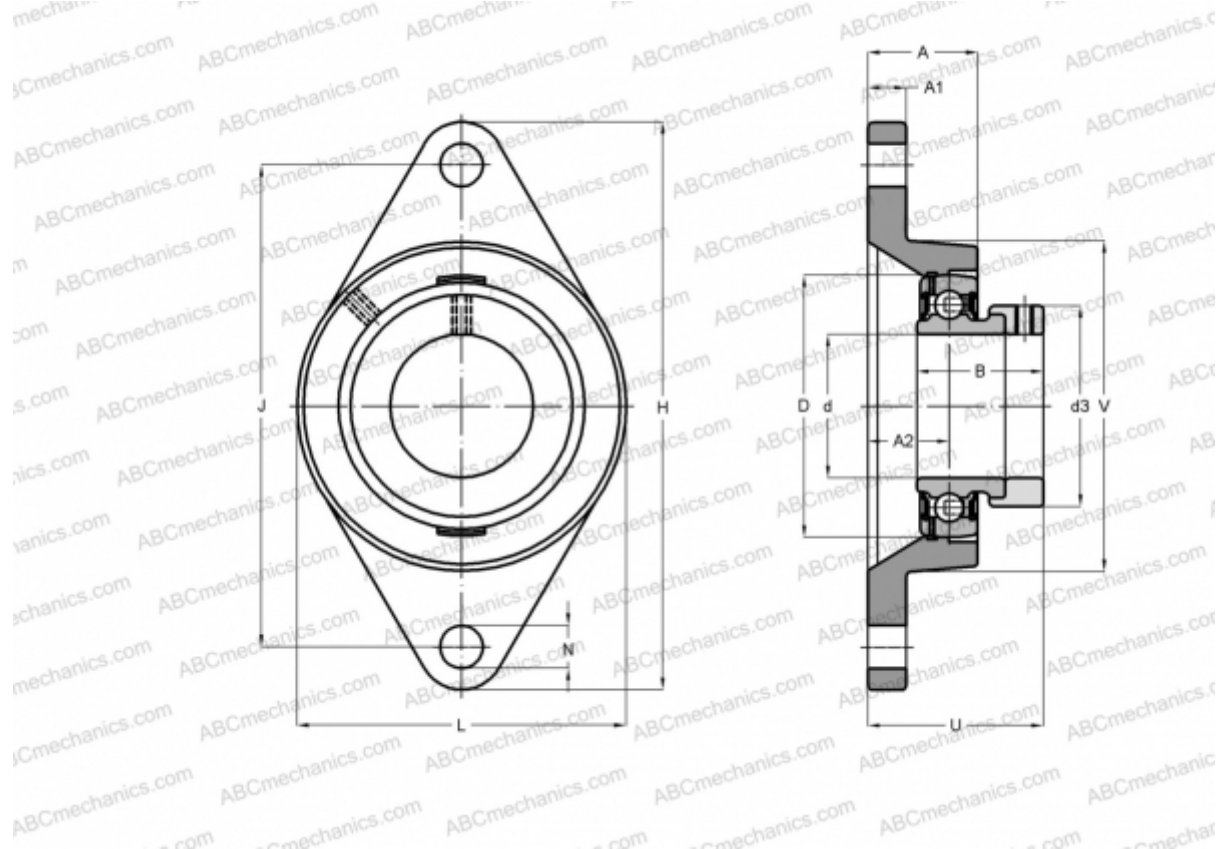

Technical specification

DIMENSIONS, MM

d	12,000
D	40,000
B	28,600
L	57,000
H	99,000
A	25,500
J	76,500
A1	11,000
A2	15,000
N	12,000
S	6,500
d3	28,600
U	37,100
Q	M6x1

WEIGHT, KG

	0,400
Bearing	ES201
Housing	FL203

MANUFACTURER

[SNR](#)

INTERCHANGE

ABC	ESFL201
-----	-------------------------

CALCULATION DATA

Basic dynamic load rating, C	9,550 kN
Basic static load rating, Co	4,780 kN
Operating temperature min	-20 °C
Operating temperature max	110 °C