

EXFL205 ABC

Ball bearing units

TYPE: Housing units, Two-bolt flanged housing units, Cast iron housing, Radial insert ball bearing with eccentric locking collar, With inner ring extended on both sides, massive bearing units

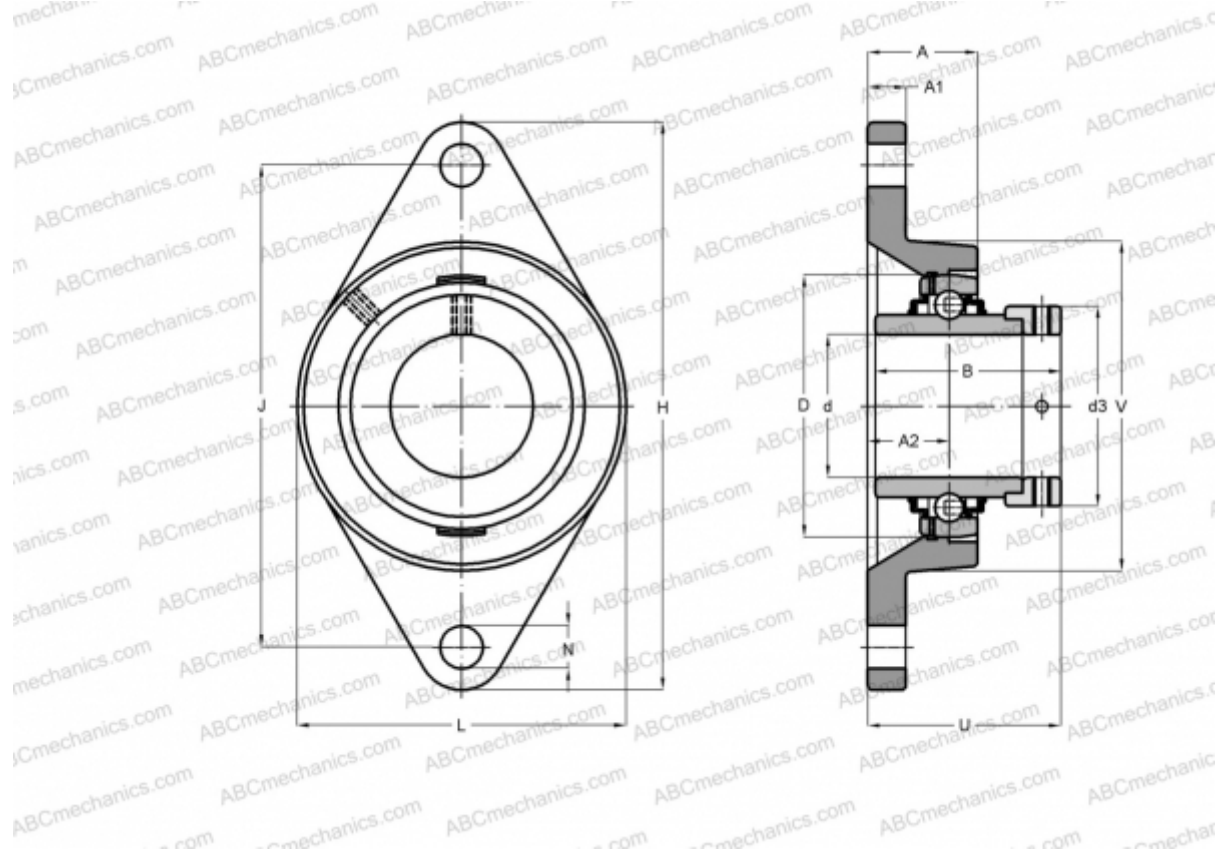

Technical specification

DIMENSIONS, MM

d	25,000
D	52,000
B	44,300
L	68,000
H	130,000
A	27,000
J	99,000
A1	13,000
A2	16,000
N	16,000
S	17,400
d3	38,100
U	42,900
Q	M6x1

WEIGHT, KG

	0,700
Bearing	EX205
Housing	FL205

MANUFACTURER

[ABC](#)

INTERCHANGE

SNR	EXFL205
-----	-------------------------