

## USFL203 SNR

Ball bearing units

TYPE: Housing units, Two-bolt flanged housing units, Cast iron housing, Radial insert ball bearing with grub screws in inner ring, With inner ring extended at one side, wide base, massive bearing units

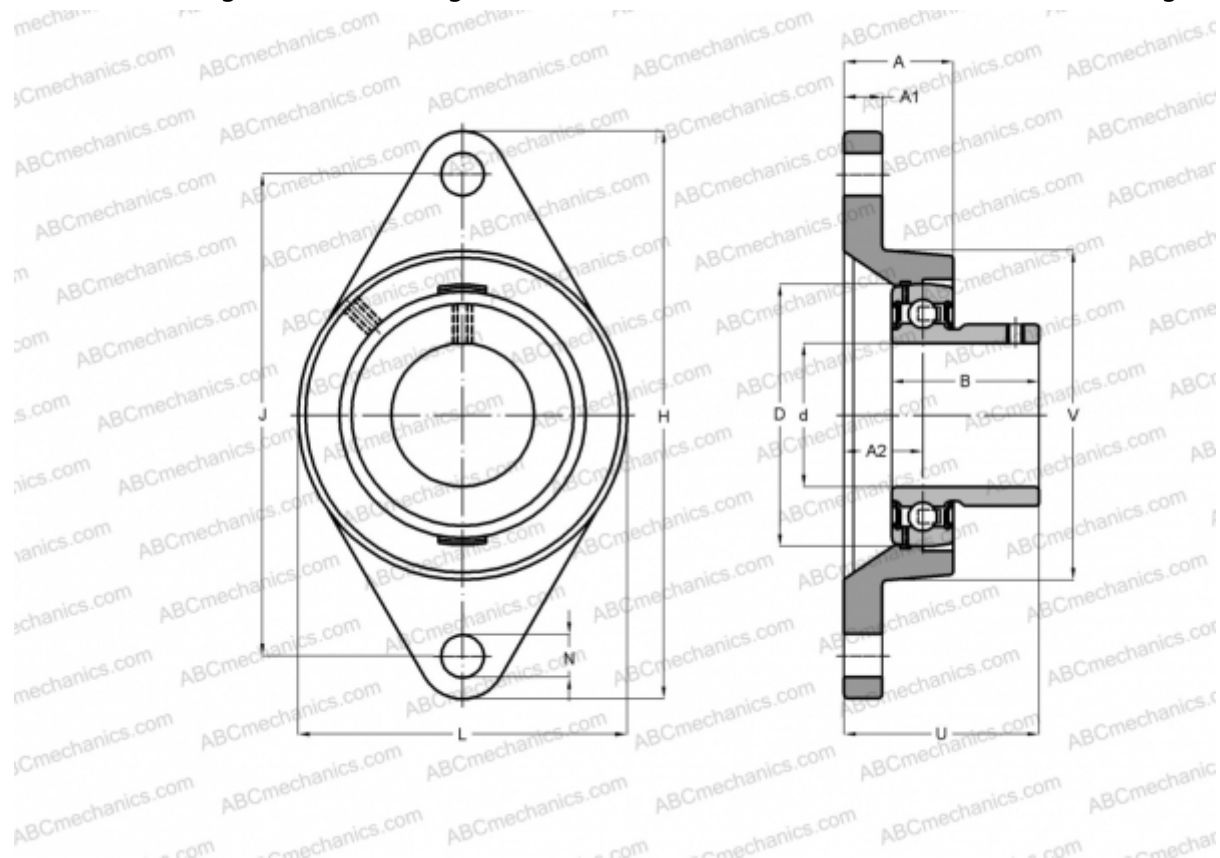

### Technical specification

#### DIMENSIONS, MM

d	17,000
D	40,000
B	22,000
L	57,000
H	99,000
A	25,500
J	76,500
A1	11,000
A2	15,000
N	12,000
S	6,000
U	31,000
Q	M6x1

Bearing	US203
Housing	FL203

#### MANUFACTURER

[SNR](#)

#### INTERCHANGE

ABC	<a href="#">USFL203</a>
-----	-------------------------

#### CALCULATION DATA

Basic dynamic load rating, C	9,550 kN
Basic static load rating, Co	4,780 kN
Operating temperature min	-20 °C
Operating temperature max	110 °C

#### WEIGHT, KG

0,400