

USFL205 SNR

Ball bearing units

TYPE: Housing units, Two-bolt flanged housing units, Cast iron housing, Radial insert ball bearing with grub screws in inner ring, With inner ring extended at one side, wide base, massive bearing units

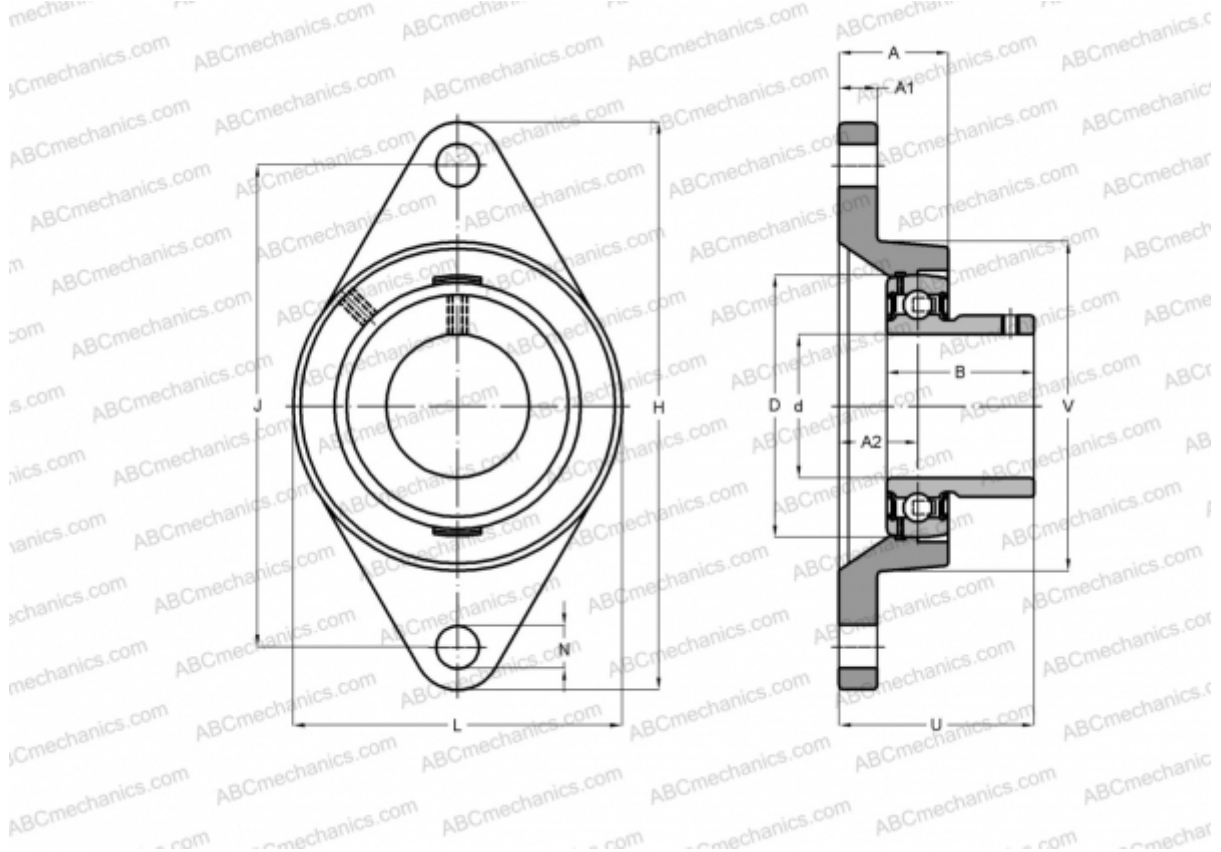

Technical specification

DIMENSIONS, MM

d	25,000
D	52,000
B	27,000
L	68,000
H	130,000
A	27,000
J	99,000
A1	13,000
A2	16,000
N	16,000
S	7,500
U	35,500
Q	M6x1

WEIGHT, KG 0,600

Bearing	US205
Housing	FL205

MANUFACTURER

[SNR](#)

INTERCHANGE

ABC	USFL205
ASAHI	BFL 205

CALCULATION DATA

Basic dynamic load rating, C	14,000 kN
Basic static load rating, Co	7,880 kN
Operating temperature min	-20 °C
Operating temperature max	110 °C