

## FYTJ 25 KF SKF

Ball bearing units

TYPE: Housing units, Two-bolt flanged housing units, Cast iron housing, Radial insert ball bearing with adapter sleeve, With inner ring extended on both sides

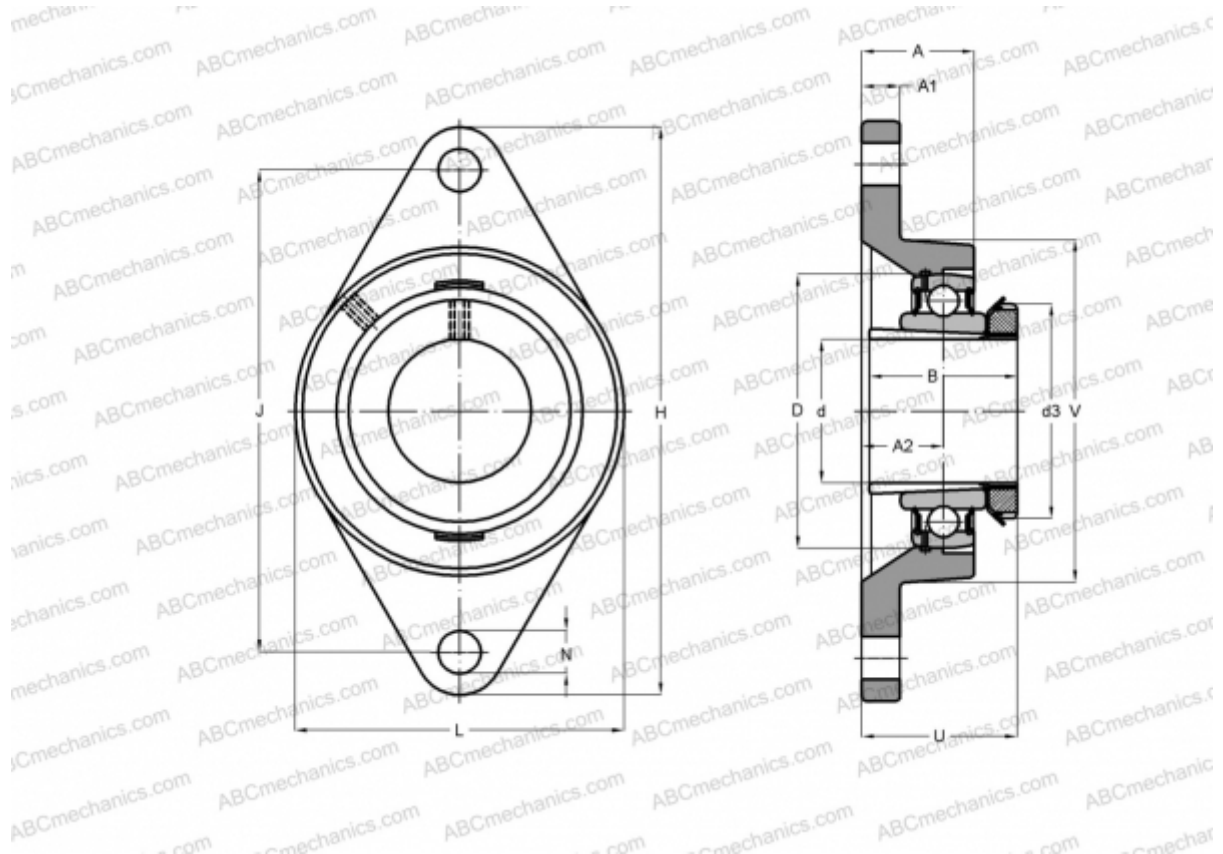

### Technical specification

#### DIMENSIONS, MM

d	20,000
D	52,000
B	35,000
L	68,000
H	130,000
A	27,000
J	99,000
A1	14,000
A2	16,000
N	16,000
d3	38,000
U	36,000
V	63,500

Bearing	YSA 205-2FK
Housing	FYTJ 505
Adapter sleeve	H 2305

#### MANUFACTURER

[SKF](#)

#### INTERCHANGE

ABC	<a href="#">UKFLE205H</a>
SNR	<a href="#">UKFLE205H</a>

#### CALCULATION DATA

Basic dynamic load rating, C	14,000 kN
Basic static load rating, Co	7,800 kN
Fatigue load limit, Pu	0,335 kN
Limiting speed	7000 r/min

**WEIGHT, KG** 0,720