

UKFLE206H SNR

Ball bearing units

TYPE: Housing units, Two-bolt flanged housing units, Cast iron housing, Radial insert ball bearing with adapter sleeve, With inner ring extended on both sides

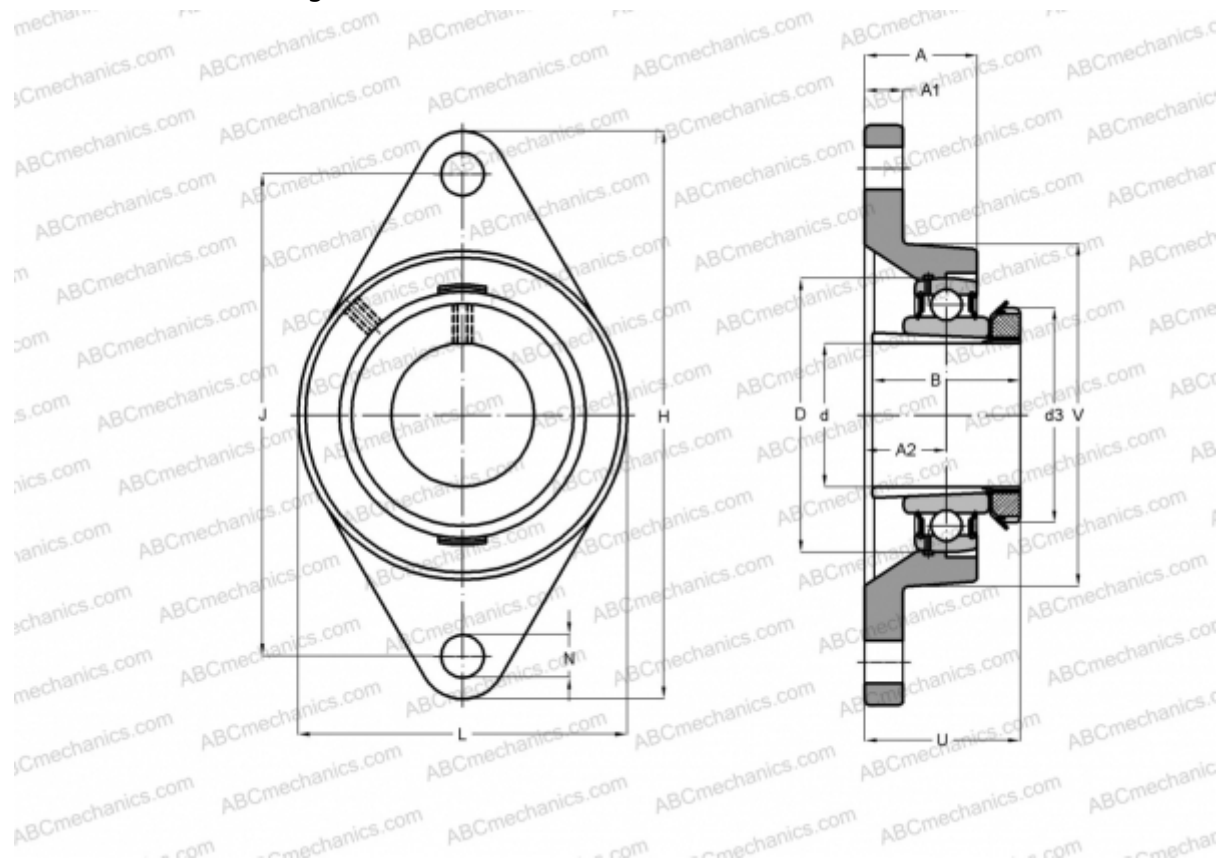

Technical specification

DIMENSIONS, MM

d	25,000
D	62,000
B	38,000
L	80,000
H	142,000
A	32,100
J	116,500
A1	12,000
A2	20,000
N	11,500
d3	45,000
U	40,500
Q	R1/8"

WEIGHT, KG 0,900

Bearing	UK206 +
Housing	FLE206
Adapter sleeve	H2306

MANUFACTURER

[SNR](#)

INTERCHANGE

ABC	UKFLE206H
SKF	FYTJ 30 KF

CALCULATION DATA

Basic dynamic load rating, C	19,500 kN
Basic static load rating, Co	11,200 kN
Operating temperature min	-20 °C
Operating temperature max	110 °C