

## UKFLE207H ABC

Ball bearing units

TYPE: Housing units, Two-bolt flanged housing units, Cast iron housing, Radial insert ball bearing with adapter sleeve, With inner ring extended on both sides

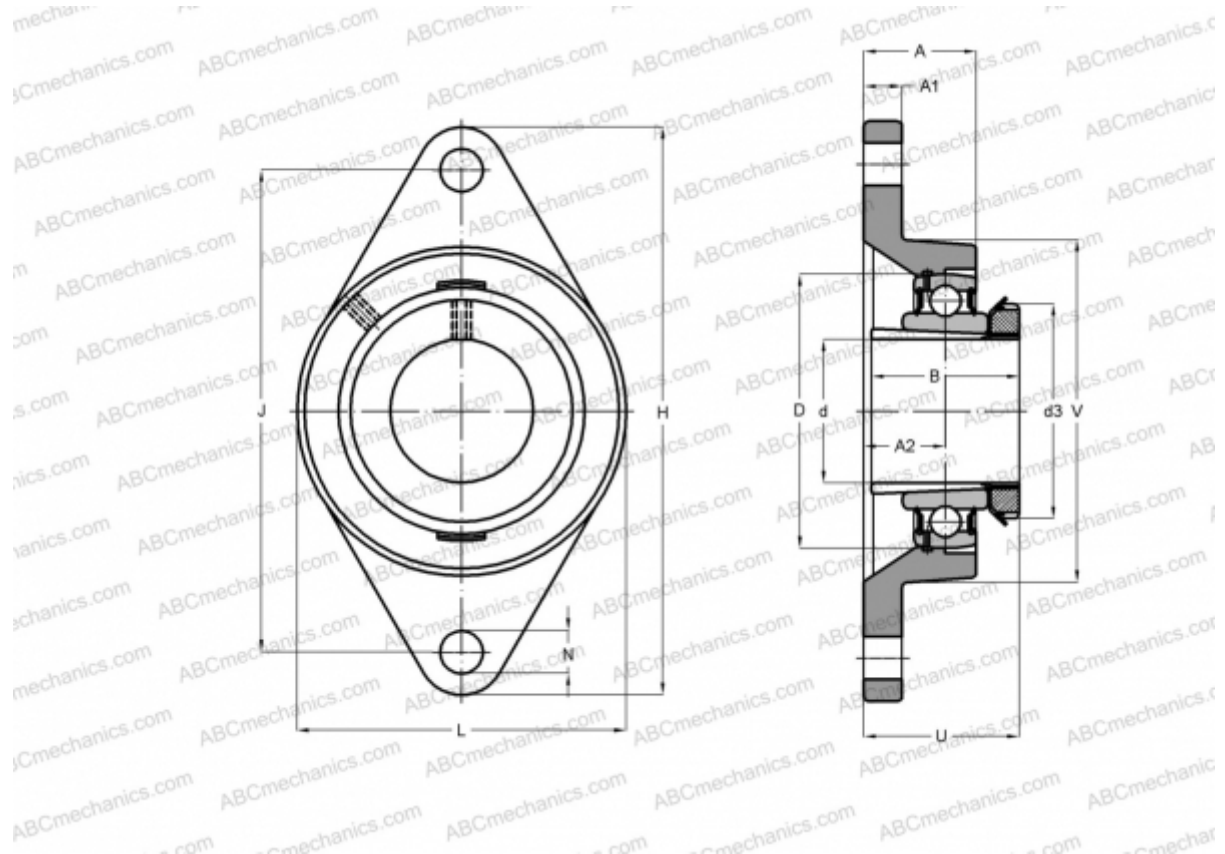

### Technical specification

#### DIMENSIONS, MM

d	30,000
D	72,000
B	43,000
L	92,000
H	155,000
A	33,700
J	130,000
A1	12,500
A2	21,000
N	14,000
d3	52,000
U	43,500
Q	R1/8"

Bearing	UK207 +
Housing	FLE207
Adapter sleeve	H2307

#### MANUFACTURER

[ABC](#)

#### INTERCHANGE

SKF	<a href="#">FYTJ 35 KF</a>
SNR	<a href="#">UKFLE207H</a>

#### WEIGHT, KG

1,200