

UKFL305H ABC

Ball bearing units

TYPE: Housing units, Two-bolt flanged housing units, Cast iron housing, Radial insert ball bearing with adapter sleeve, With inner ring extended on both sides, massive bearing units

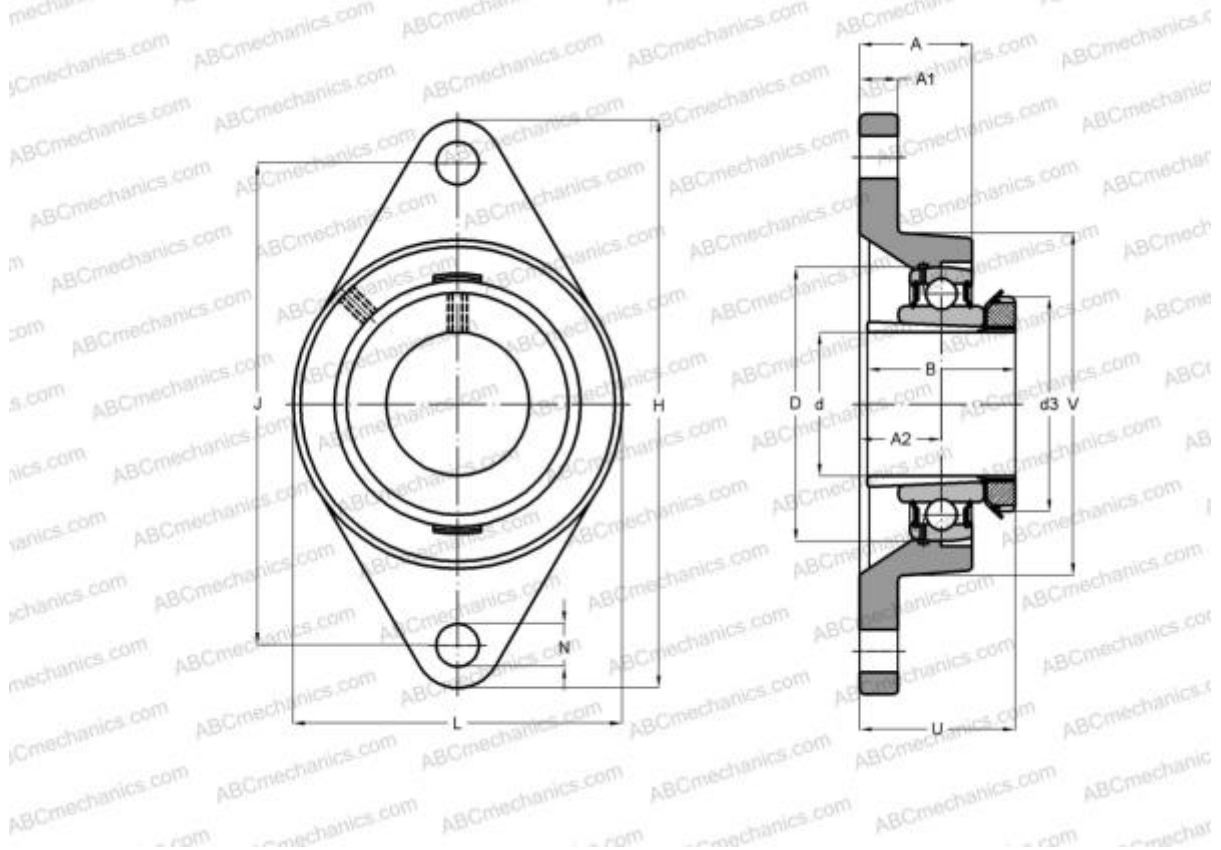

Technical specification

DIMENSIONS, MM

d	20,000
D	62,000
B	35,000
L	80,000
H	150,000
A	29,000
J	113,000
A1	13,000
A2	16,000
N	19,000
d3	38,000
U	37,500
Q	M6x1

Bearing	UK305 +
Housing	FL305
Adapter sleeve	H2305

MANUFACTURER

[ABC](#)

INTERCHANGE

SNR	UKFL305H
-----	--------------------------

WEIGHT, KG 1,100