

UKFL306H SNR

Ball bearing units

TYPE: Housing units, Two-bolt flanged housing units, Cast iron housing, Radial insert ball bearing with adapter sleeve, With inner ring extended on both sides, massive bearing units

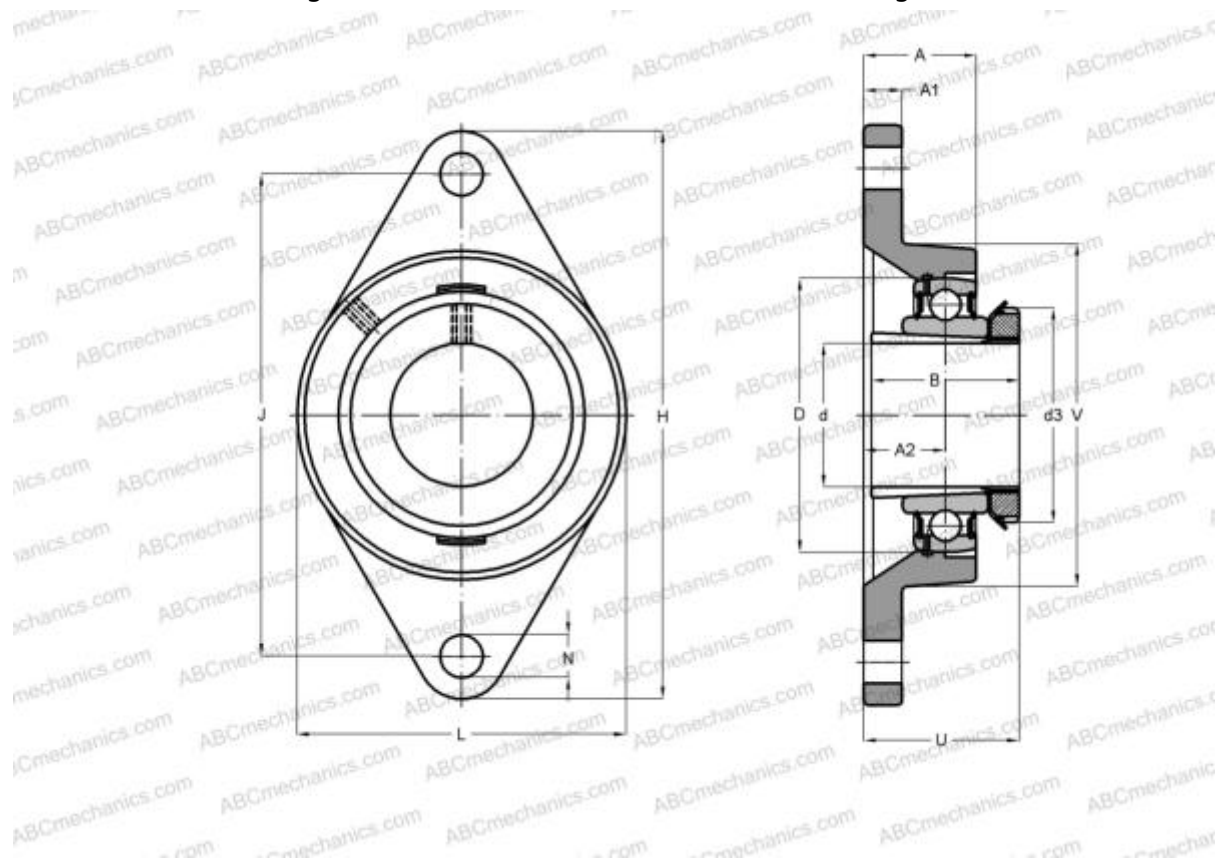

Technical specification

DIMENSIONS, MM

d	25,000
D	72,000
B	38,000
L	90,000
H	180,000
A	32,000
J	134,000
A1	15,000
A2	18,000
N	23,000
d3	45,000
U	41,000
Q	M6x1

Bearing	UK306 +
Housing	FL306
Adapter sleeve	H2306

MANUFACTURER

[SNR](#)

INTERCHANGE

ABC	UKFL306H
-----	--------------------------

CALCULATION DATA

Basic dynamic load rating, C	27,000 kN
Basic static load rating, Co	15,200 kN
Operating temperature min	-20 °C
Operating temperature max	110 °C

WEIGHT, KG

1,400