

## EXPH201 ABC

Ball bearing units

TYPE: Housing units, Plummer block, Cast iron housing, Radial insert ball bearing with eccentric locking collar, With inner ring extended on both sides, high units

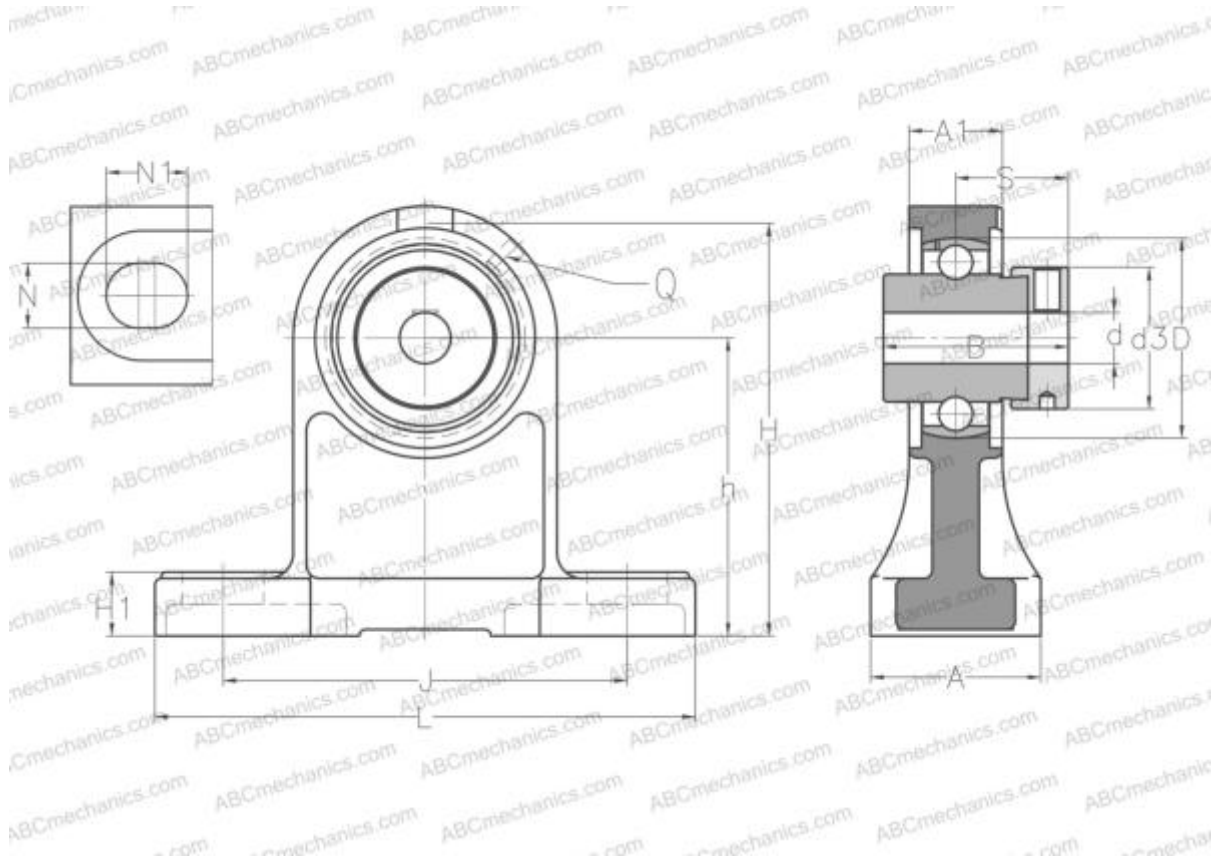

### Technical specification

#### DIMENSIONS, MM

d	12,000
D	47,000
B	43,500
L	127,000
H	101,000
A	22,000
J	95,000
A1	40,000
H1	15,000
N	13,000
N1	19,000
S	26,500
d3	33,300
h	70,000
Q	M6x1

#### WEIGHT, KG

	1,000
Bearing	EX201
Housing	PH204

#### MANUFACTURER

[ABC](#)

#### INTERCHANGE

SNR	<a href="#">EXPH201</a>
-----	-------------------------