

USPH201 ABC

Ball bearing units

TYPE: Housing units, Plummer block, Cast iron housing, Radial insert ball bearing with grub screws in inner ring, With inner ring extended at one side, high units

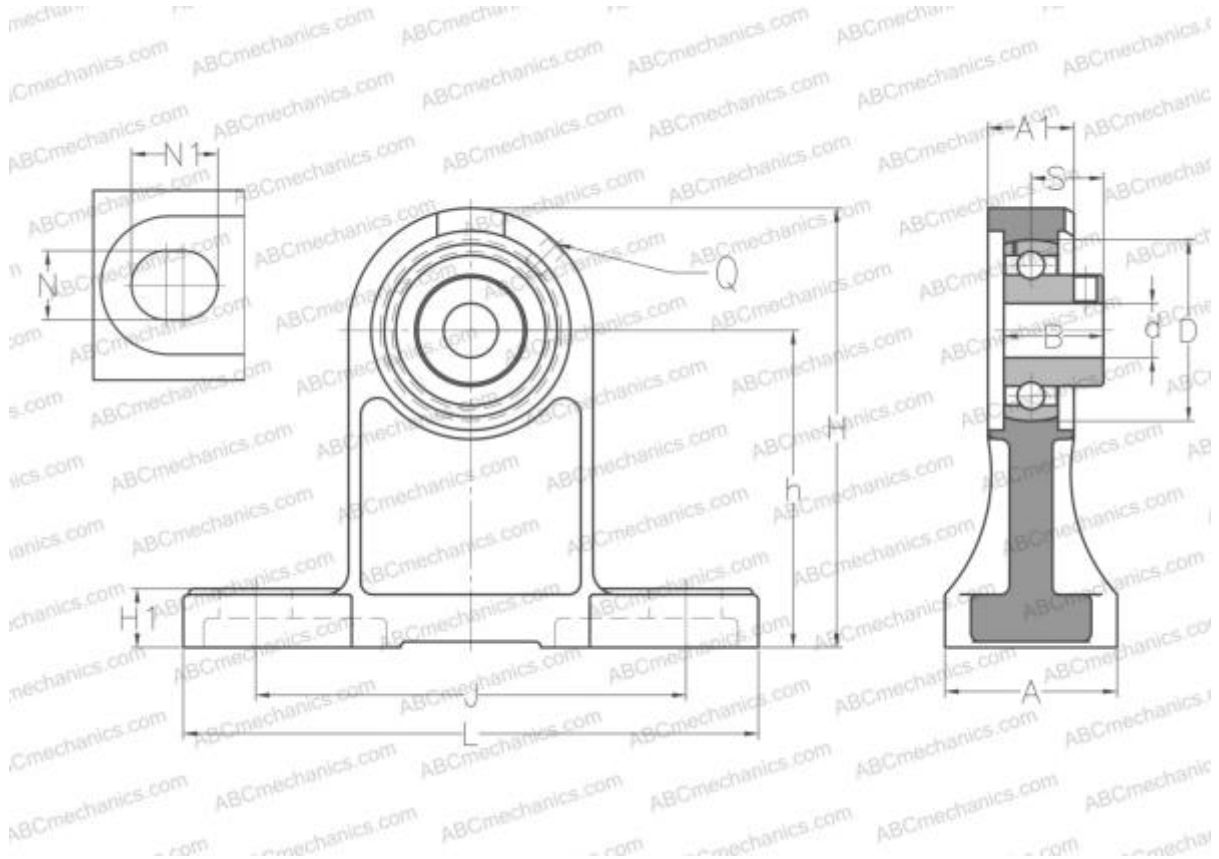

Technical specification

DIMENSIONS, MM

d	12,000
D	40,000
B	22,000
L	127,000
H	97,000
A	19,000
J	95,000
A1	38,000
H1	13,000
N	12,000
N1	16,000
S	16,000
h	70,000
Q	M6x1

WEIGHT, KG

Bearing	0,700
Housing	US201
	PH203

MANUFACTURER

[ABC](#)

INTERCHANGE

SNR	USPH201
-----	-------------------------