

## USPH201 SNR

Ball bearing units

TYPE: Housing units, Plummer block, Cast iron housing, Radial insert ball bearing with grub screws in inner ring, With inner ring extended at one side, high units

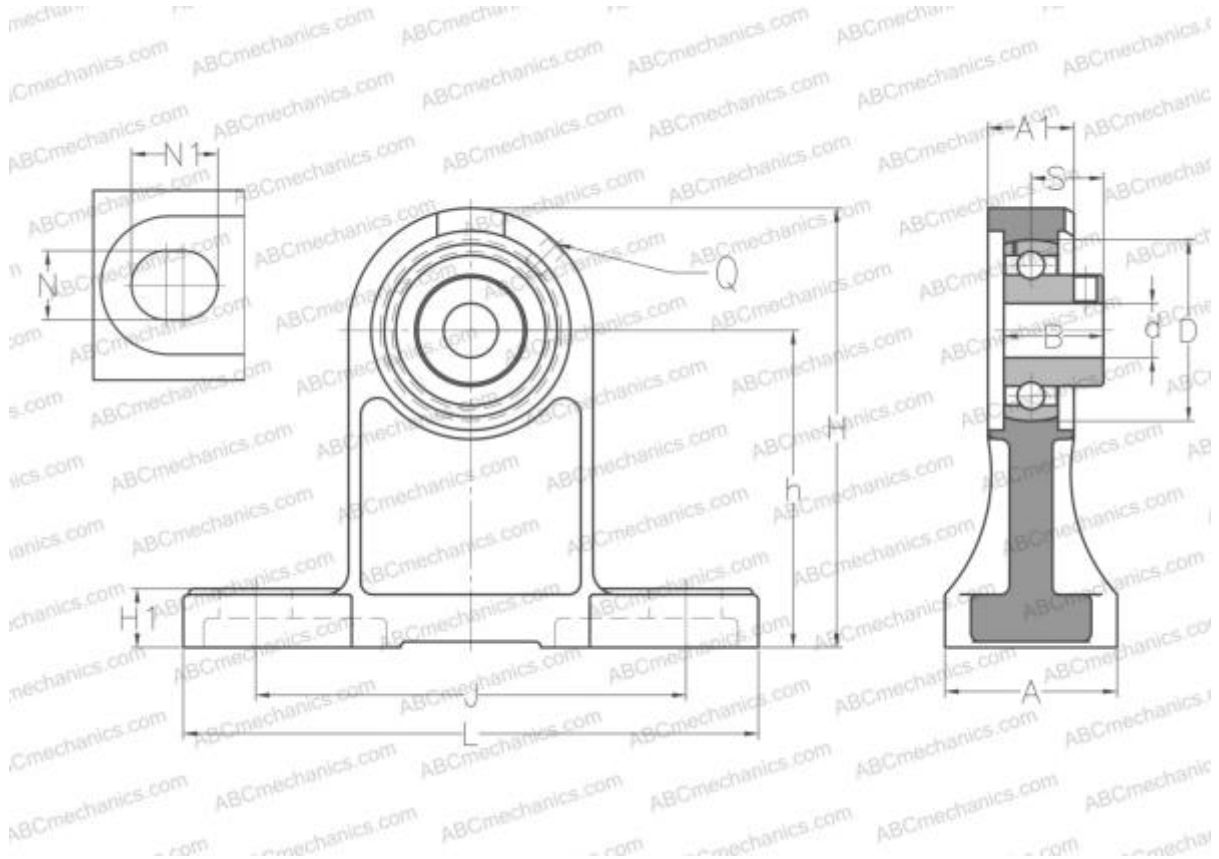

### Technical specification

#### DIMENSIONS, MM

d	12,000
D	40,000
B	22,000
L	127,000
H	97,000
A	19,000
J	95,000
A1	38,000
H1	13,000
N	12,000
N1	16,000
S	16,000
h	70,000
Q	M6x1

#### WEIGHT, KG

	0,700
Bearing	US201
Housing	PH203

#### MANUFACTURER

[SNR](#)

#### INTERCHANGE

ABC	<a href="#">USPH201</a>
-----	-------------------------

#### CALCULATION DATA

Basic dynamic load rating, C	9,550 kN
Basic static load rating, Co	4,780 kN
Operating temperature min	-20 °C
Operating temperature max	110 °C