

UKPH205H SNR

Ball bearing units

TYPE: Housing units, Plummer block, Cast iron housing, Radial insert ball bearing with adapter sleeve, With inner ring extended on both sides, high units

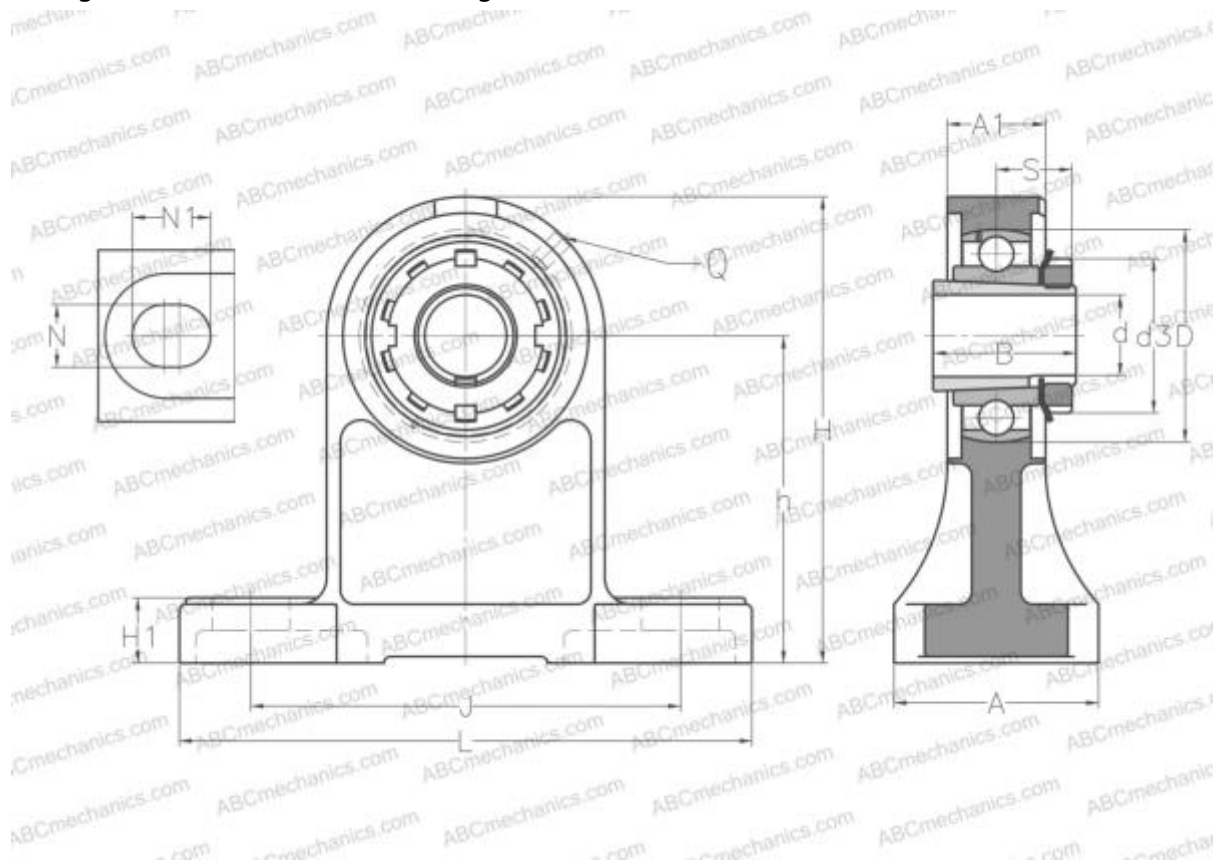

Technical specification

DIMENSIONS, MM

d	20,000
D	52,000
B	35,000
L	140,000
H	114,000
A	24,000
J	105,000
A1	50,000
H1	16,000
N	13,000
N1	19,000
S	18,500
d3	38,000
h	80,000
Q	M6x1

WEIGHT, KG

	1,200
Bearing	UK205 +
Housing	PH205
Adapter sleeve	H2305

MANUFACTURER

[SNR](#)

INTERCHANGE

ABC [UKPH205H](#)

CALCULATION DATA

Basic dynamic load rating, C	14,000 kN
Basic static load rating, Co	7,880 kN
Operating temperature min	-20 °C
Operating temperature max	110 °C