

UKPH206H ABC

Ball bearing units

TYPE: Housing units, Plummer block, Cast iron housing, Radial insert ball bearing with adapter sleeve, With inner ring extended on both sides, high units

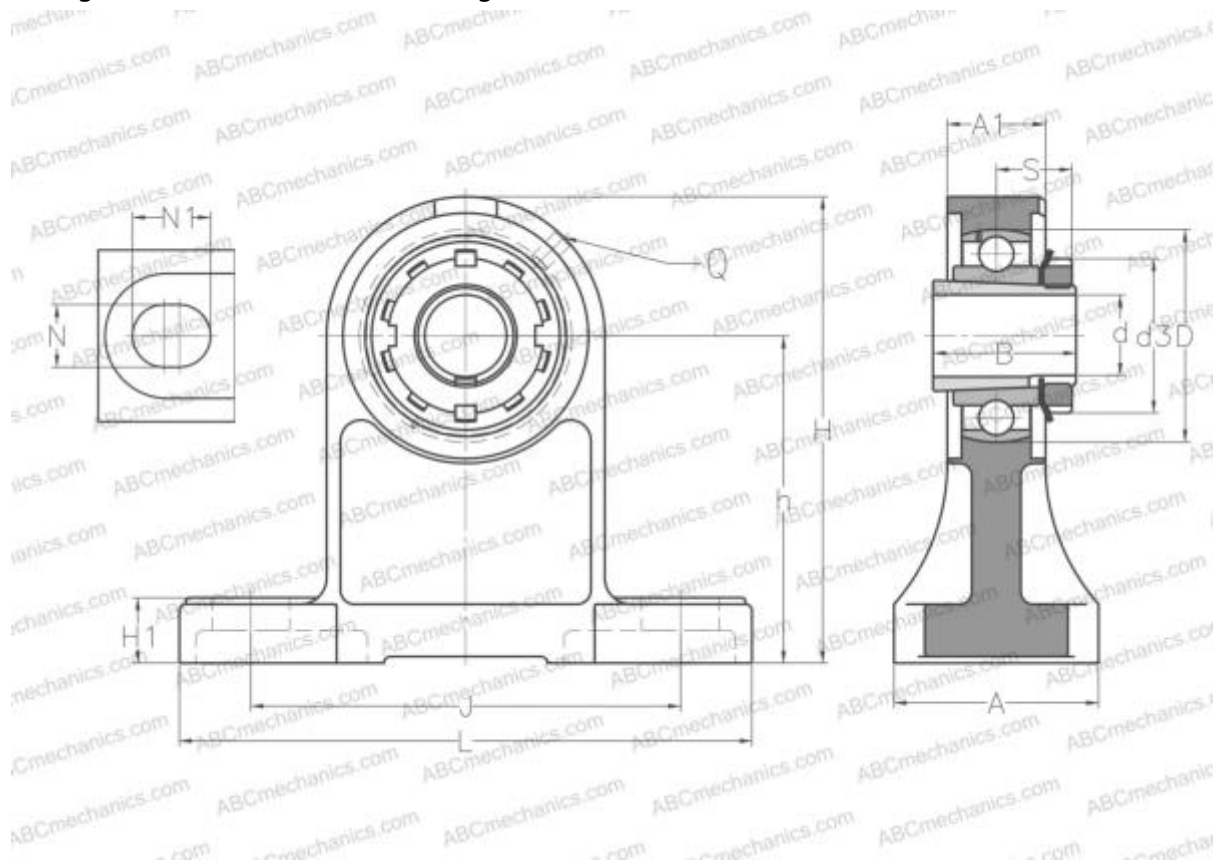

Technical specification

DIMENSIONS, MM

d	25,000
D	62,000
B	38,000
L	165,000
H	130,000
A	28,000
J	121,000
A1	50,000
H1	18,000
N	17,000
N1	21,000
S	20,500
d3	45,000
h	90,000
Q	M6x1

WEIGHT, KG

	1,800
Bearing	UK206 +
Housing	PH206
Adapter sleeve	H2306

MANUFACTURER

[ABC](#)

INTERCHANGE

SNR [UKPH206H](#)