

UKPH207H SNR

Ball bearing units

TYPE: Housing units, Plummer block, Cast iron housing, Radial insert ball bearing with adapter sleeve, With inner ring extended on both sides, high units

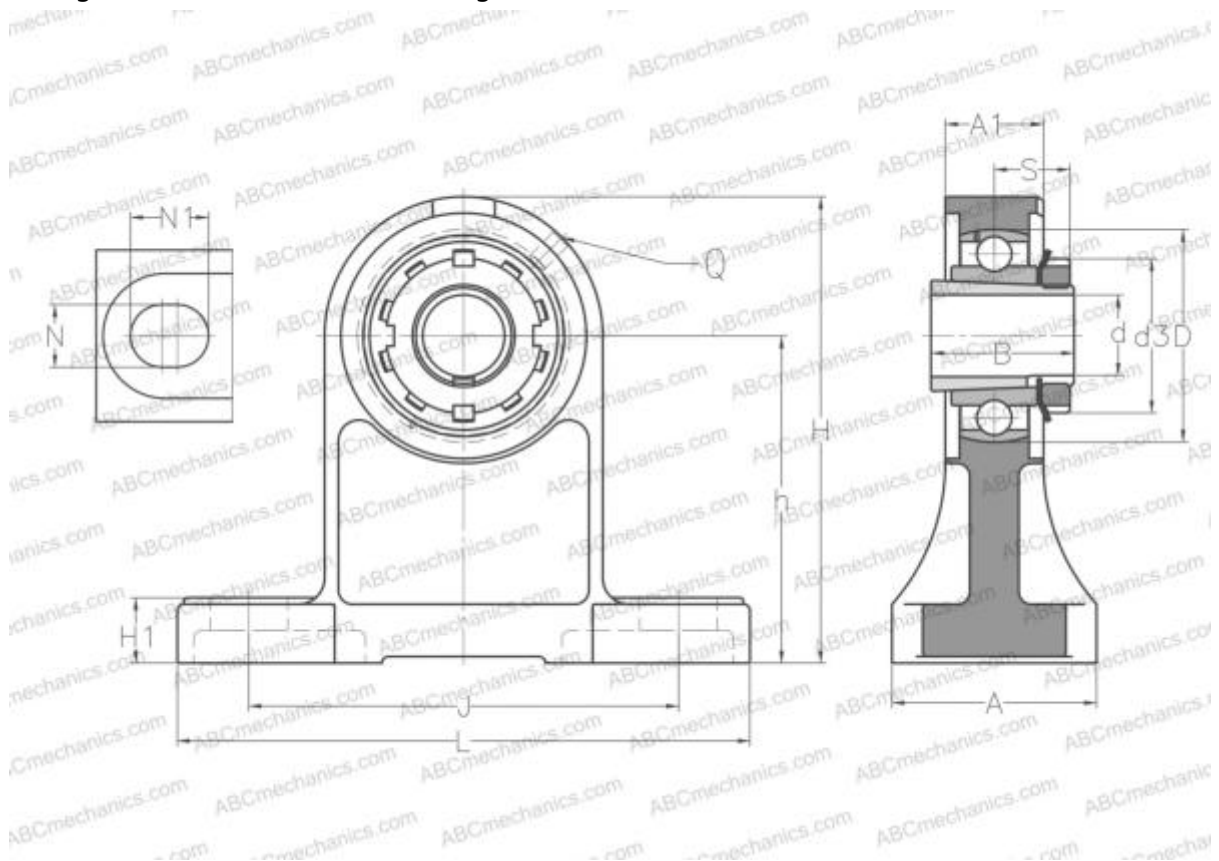

Technical specification

DIMENSIONS, MM

d	30,000
D	72,000
B	43,000
L	167,000
H	140,000
A	30,000
J	127,000
A1	60,000
H1	19,000
N	17,000
N1	21,000
S	22,500
d3	52,000
h	95,000
Q	M6x1

WEIGHT, KG

	2,300
Bearing	UK207 +
Housing	PH207
Adapter sleeve	H2307

MANUFACTURER

[SNR](#)

INTERCHANGE

ABC [UKPH207H](#)

CALCULATION DATA

Basic dynamic load rating, C	25,700 kN
Basic static load rating, Co	15,200 kN
Operating temperature min	-20 °C
Operating temperature max	110 °C