

UKPH209H SNR

Ball bearing units

TYPE: Housing units, Plummer block, Cast iron housing, Radial insert ball bearing with adapter sleeve, With inner ring extended on both sides, high units

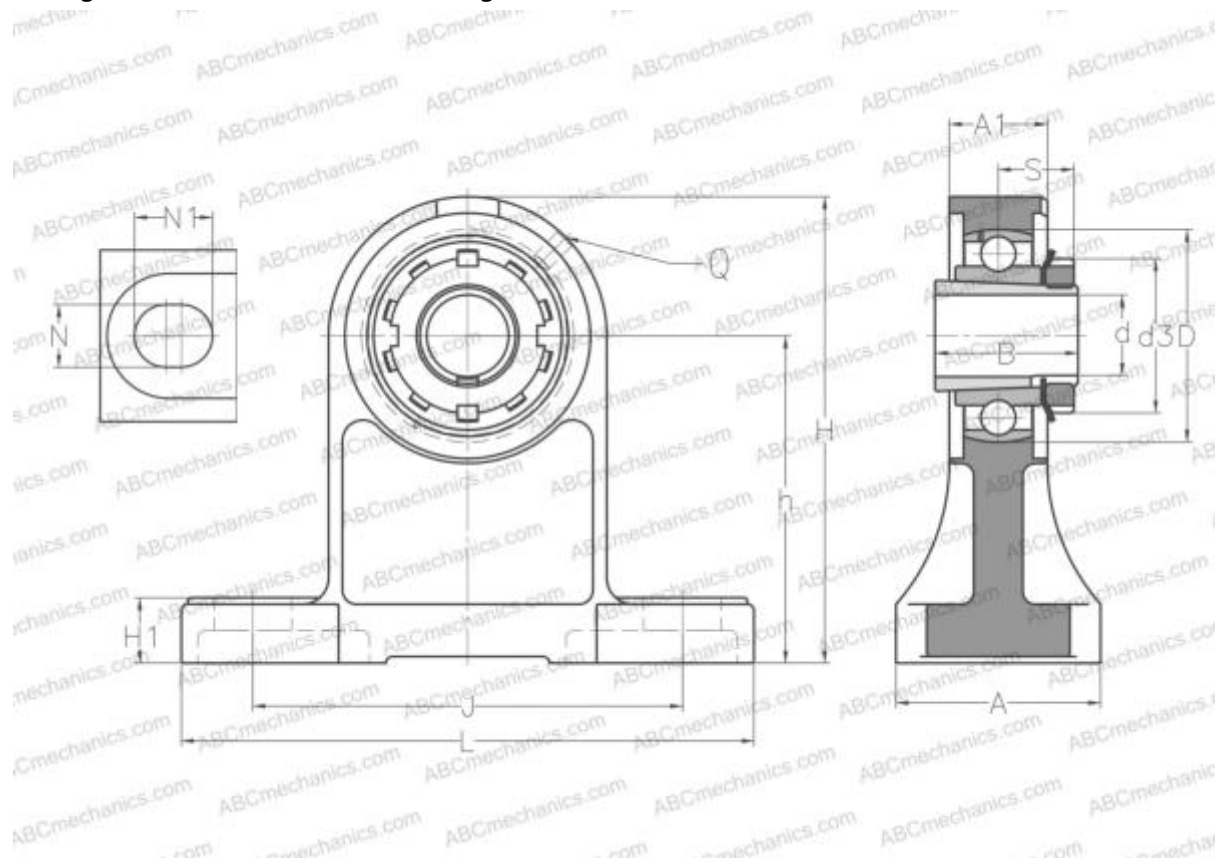

Technical specification

DIMENSIONS, MM

d	40,000
D	85,000
B	50,000
L	190,000
H	157,000
A	36,000
J	146,000
A1	70,000
H1	20,000
N	17,000
N1	25,000
S	26,000
d3	65,000
h	105,000
Q	M6x1

WEIGHT, KG

	3,300
Bearing	UK209 +
Housing	PH209
Adapter sleeve	H2309

MANUFACTURER

[SNR](#)

INTERCHANGE

ABC [UKPH209H](#)

CALCULATION DATA

Basic dynamic load rating, C	31,850 kN
Basic static load rating, Co	20,800 kN
Operating temperature min	-20 °C
Operating temperature max	110 °C