

УКРАЕ205Н ABC

Ball bearing units

TYPE: Housing units, Plummer block, Narrow cast iron housing, Radial insert ball bearing with adapter sleeve, Подшипниковые узлы

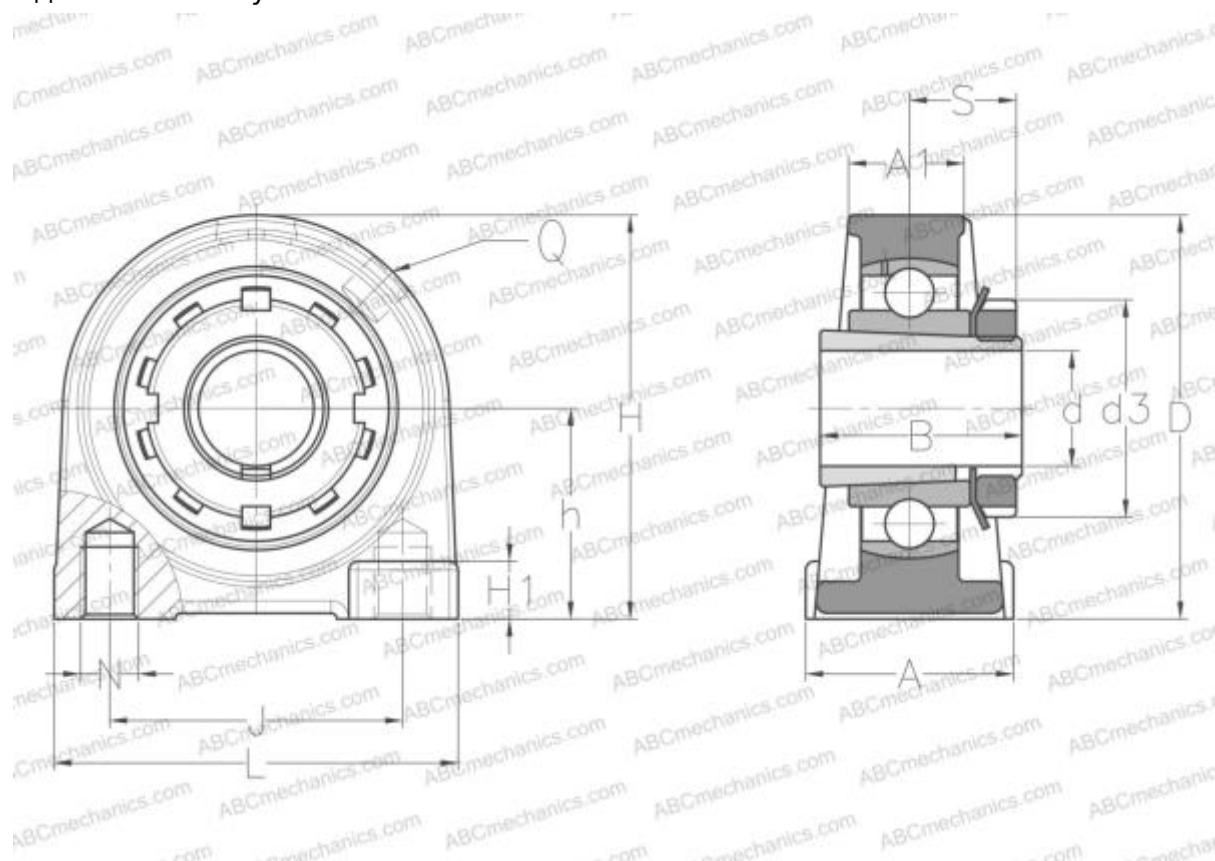

Technical specification

DIMENSIONS, MM

d	20,000
D	52,000
B	35,000
L	70,000
H	70,000
A	36,000
J	50,800
A1	21,000
H1	10,000
S	18,500
d3	38,000
h	36,500
Q	R1/8"

WEIGHT, KG 0,600

Bearing	UK205 +
Housing	PAE205
Adapter sleeve	H2305

MANUFACTURER

[ABC](#)

INTERCHANGE

SNR [UKPAE205H](#)