

UKPAE206H SNR

Ball bearing units

TYPE: Housing units, Plummer block, Narrow cast iron housing, Radial insert ball bearing with adapter sleeve, Подшипниковые узлы

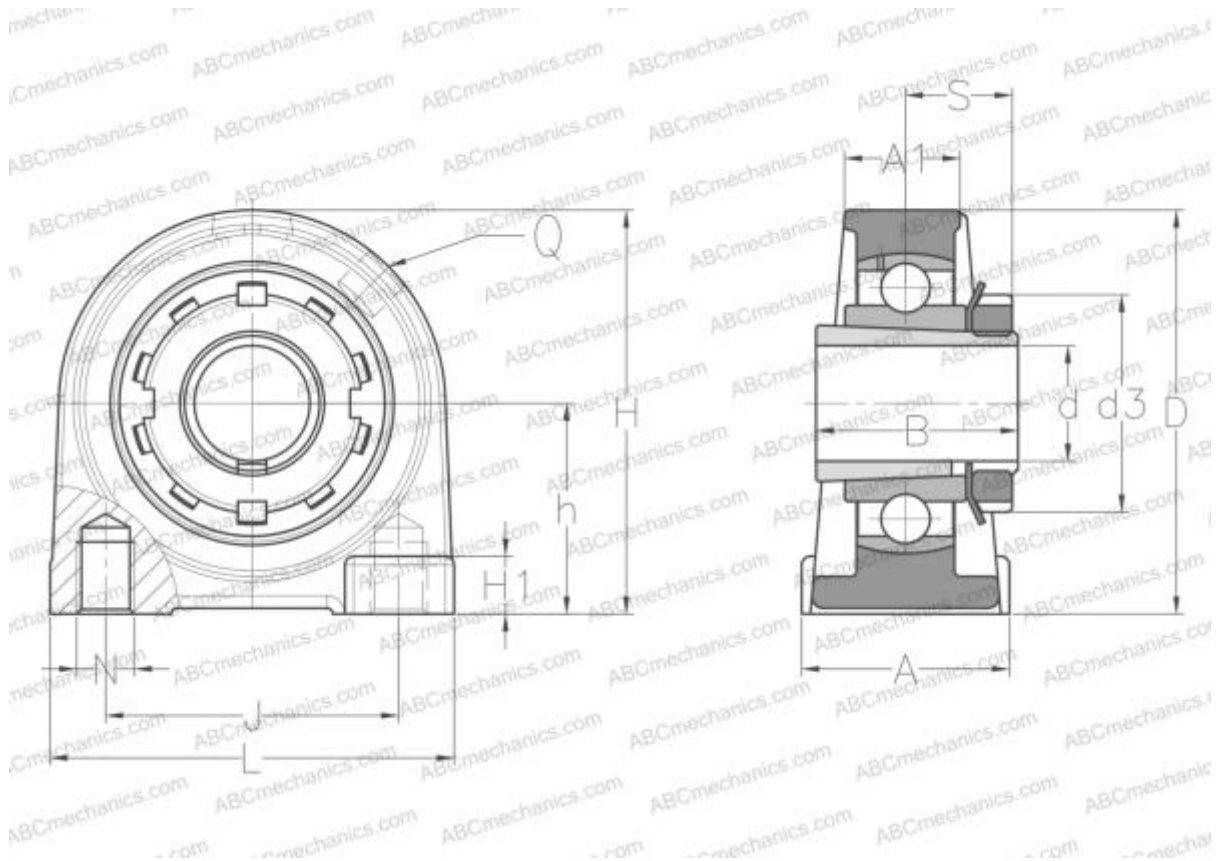

Technical specification

DIMENSIONS, MM

d	25,000
D	62,000
B	38,000
L	98,000
H	82,000
A	38,000
J	76,200
A1	25,000
H1	11,000
S	20,500
d3	45,000
h	42,900
Q	R1/8"

WEIGHT, KG 1,000

Bearing	UK206 +
Housing	PAE206
Adapter sleeve	H2306

MANUFACTURER

[SNR](#)

INTERCHANGE

ABC [UKPAE206H](#)

CALCULATION DATA

Basic dynamic load rating, C	19,500 kN
Basic static load rating, Co	11,200 kN
Operating temperature min	-20 °C
Operating temperature max	110 °C