

УКРАЕ207Н ABC

Ball bearing units

TYPE: Housing units, Plummer block, Narrow cast iron housing, Radial insert ball bearing with adapter sleeve, Подшипниковые узлы

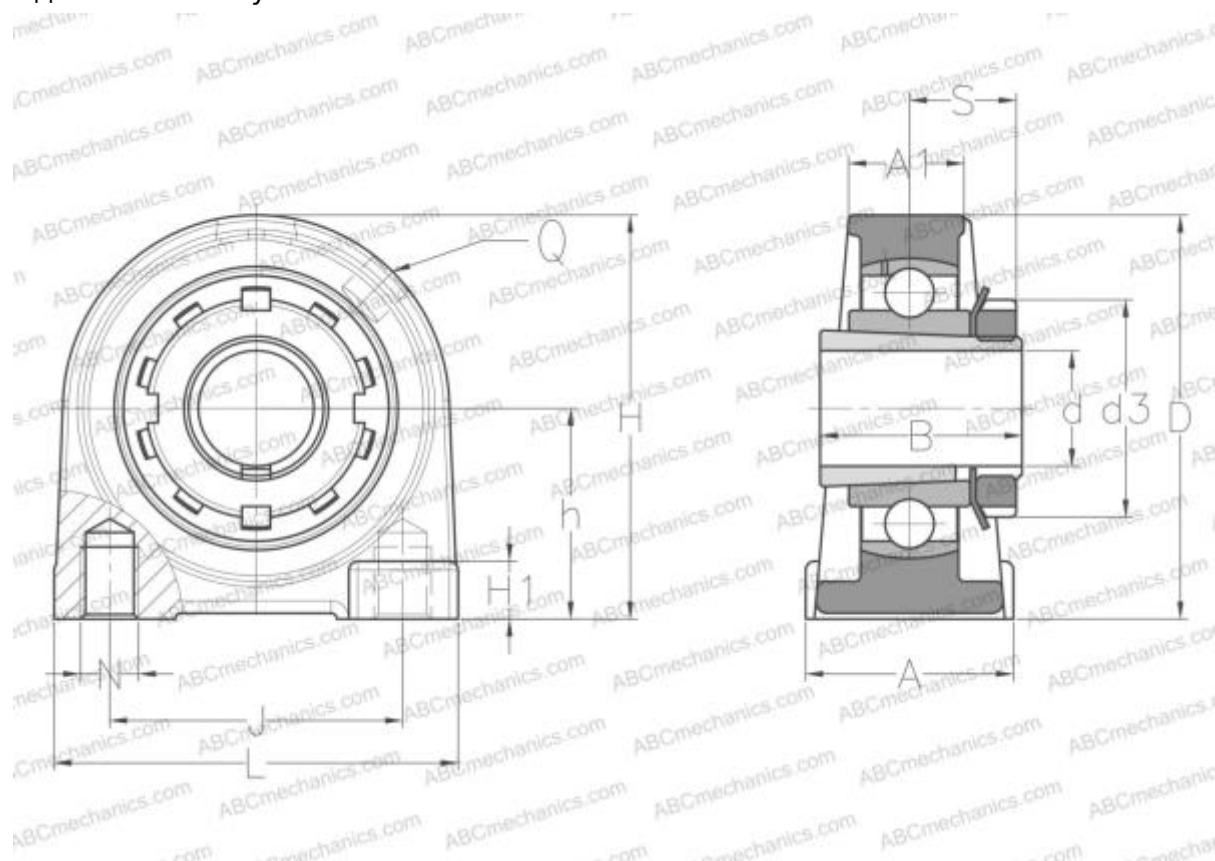

Technical specification

DIMENSIONS, MM

d	30,000
D	72,000
B	43,000
L	103,000
H	93,000
A	45,000
J	82,600
A1	27,000
H1	12,000
S	22,500
d3	52,000
h	47,600
Q	R1/8"

WEIGHT, KG 1,400

Bearing	UK207 +
Housing	PAE207
Adapter sleeve	H2307

MANUFACTURER

[ABC](#)

INTERCHANGE

SNR [UKPAE207H](#)