

УКРАЕ208Н ABC

Ball bearing units

TYPE: Housing units, Plummer block, Narrow cast iron housing, Radial insert ball bearing with adapter sleeve, Подшипниковые узлы

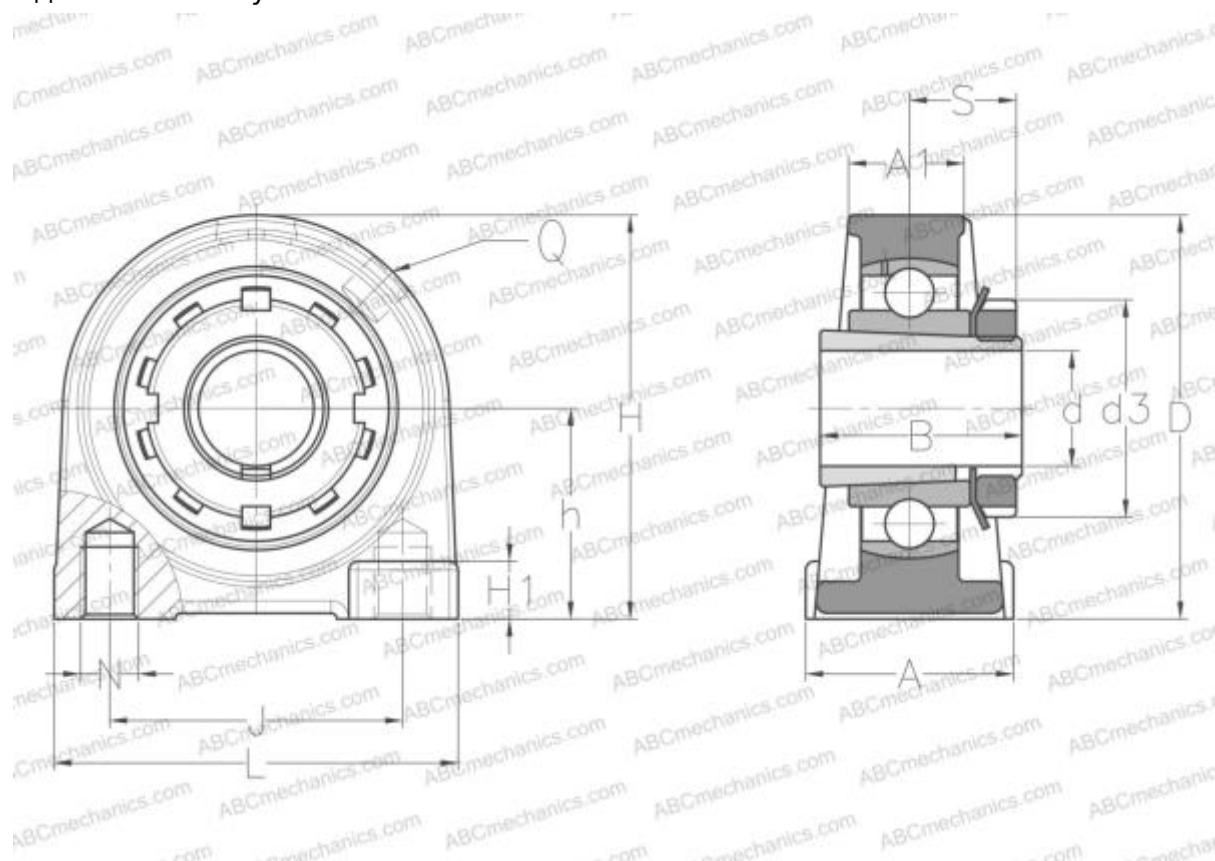

Technical specification

DIMENSIONS, MM

d	35,000
D	80,000
B	46,000
L	116,000
H	99,000
A	47,000
J	88,900
A1	30,000
H1	13,000
S	24,500
d3	58,000
h	49,200
Q	R1/8"

WEIGHT, KG 1,700

Bearing	UK208 +
Housing	PAE208
Adapter sleeve	H2308

MANUFACTURER

[ABC](#)

INTERCHANGE

SNR [UKPAE208H](#)