

UKPG205H ABC

Ball bearing units

TYPE: Housing units, Plummer block, Narrow cast iron housing, Radial insert ball bearing with adapter sleeve, With inner ring extended on both sides, wide base

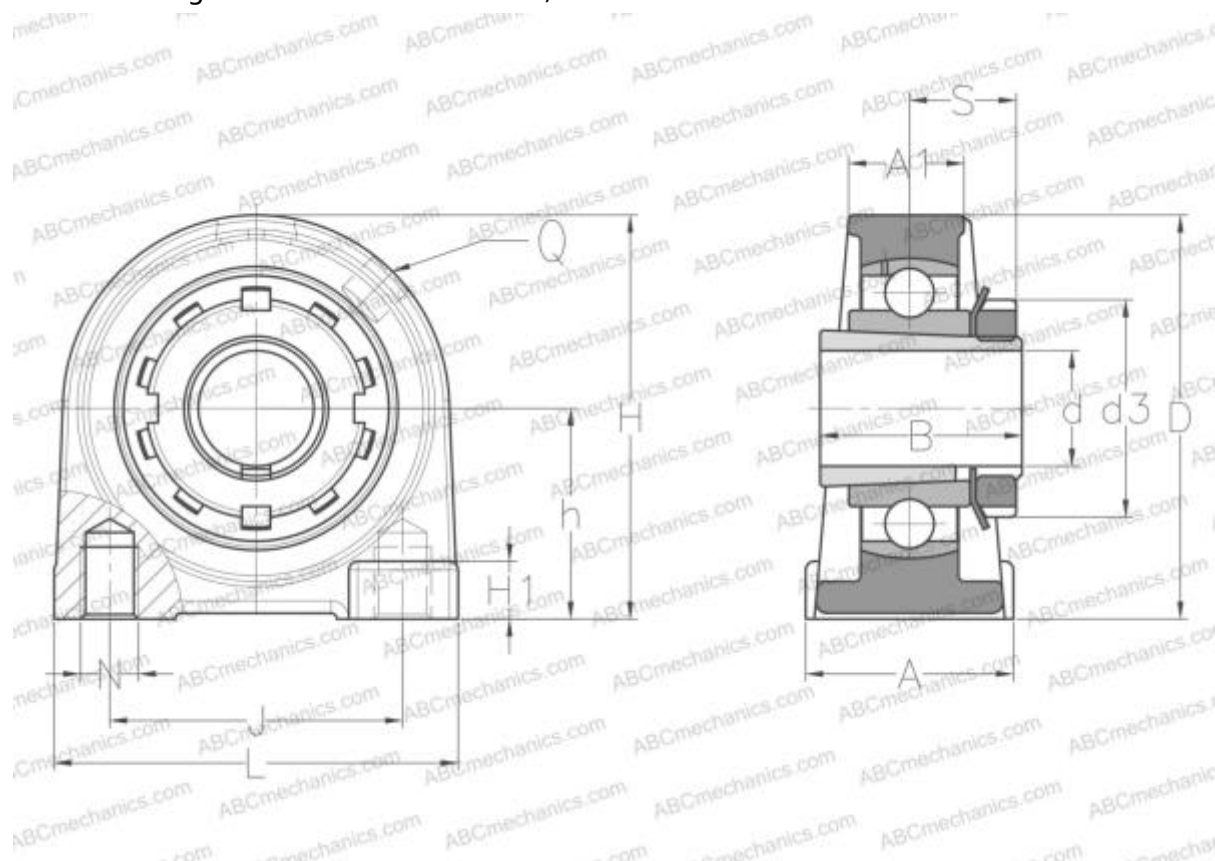

Technical specification

DIMENSIONS, MM

d	20,000
D	52,000
B	35,000
L	75,000
H	70,000
A	38,000
J	50,000
A1	25,000
H1	15,000
S	18,500
d3	38,000
h	36,500
Q	M6x1

WEIGHT, KG 0,700

Bearing	UK205 +
Housing	PG205
Adapter sleeve	H2305

MANUFACTURER

[ABC](#)

INTERCHANGE

SNR [UKPG205H](#)