

## UKPG205H SNR

Ball bearing units

TYPE: Housing units, Plummer block, Narrow cast iron housing, Radial insert ball bearing with adapter sleeve, With inner ring extended on both sides, wide base

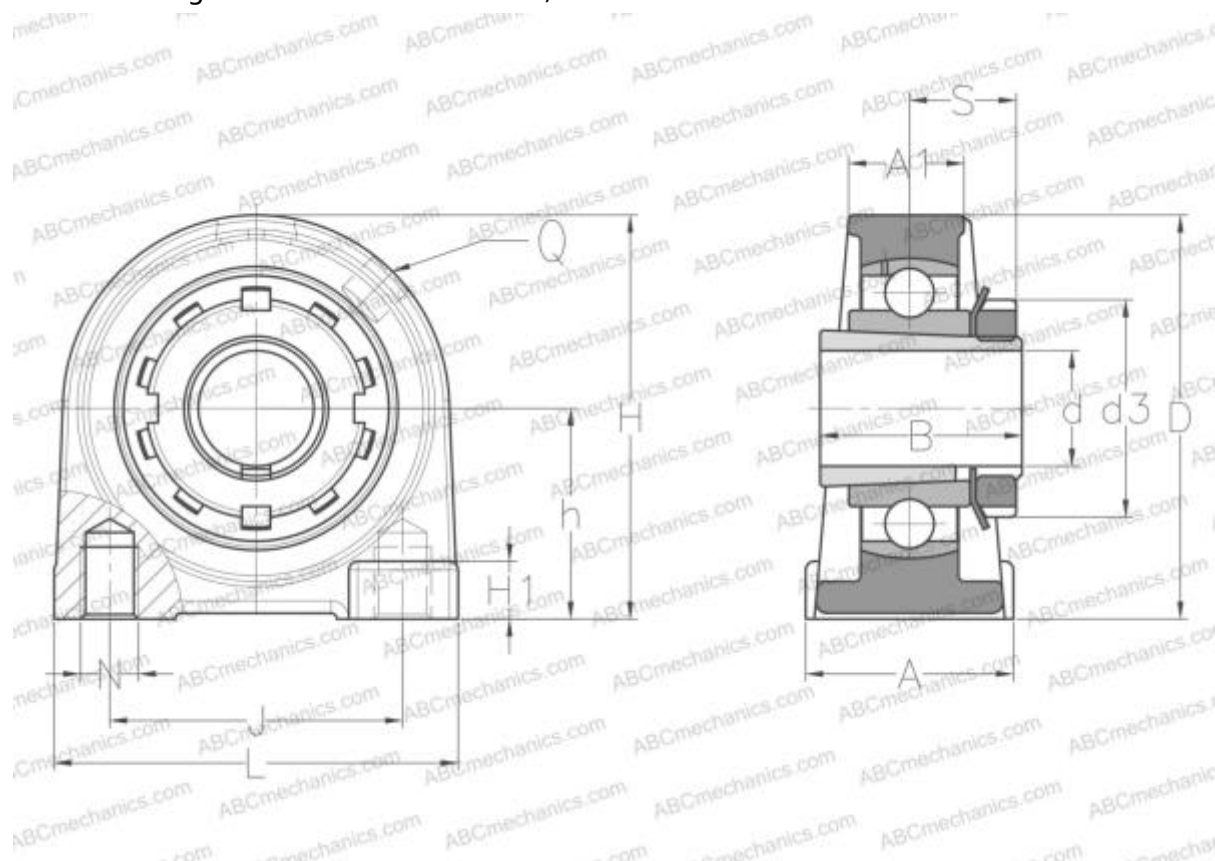

### Technical specification

#### DIMENSIONS, MM

d	20,000
D	52,000
B	35,000
L	75,000
H	70,000
A	38,000
J	50,000
A1	25,000
H1	15,000
S	18,500
d3	38,000
h	36,500
Q	M6x1

Bearing	UK205 +
Housing	PG205
Adapter sleeve	H2305

#### MANUFACTURER

[SNR](#)

#### INTERCHANGE

ABC	<a href="#">UKPG205H</a>
-----	--------------------------

#### CALCULATION DATA

Basic dynamic load rating, C	14,000 kN
Basic static load rating, Co	7,880 kN
Operating temperature min	-20 °C
Operating temperature max	110 °C

**WEIGHT, KG** 0,700