

UKPG206H ABC

Ball bearing units

TYPE: Housing units, Plummer block, Narrow cast iron housing, Radial insert ball bearing with adapter sleeve, With inner ring extended on both sides, wide base

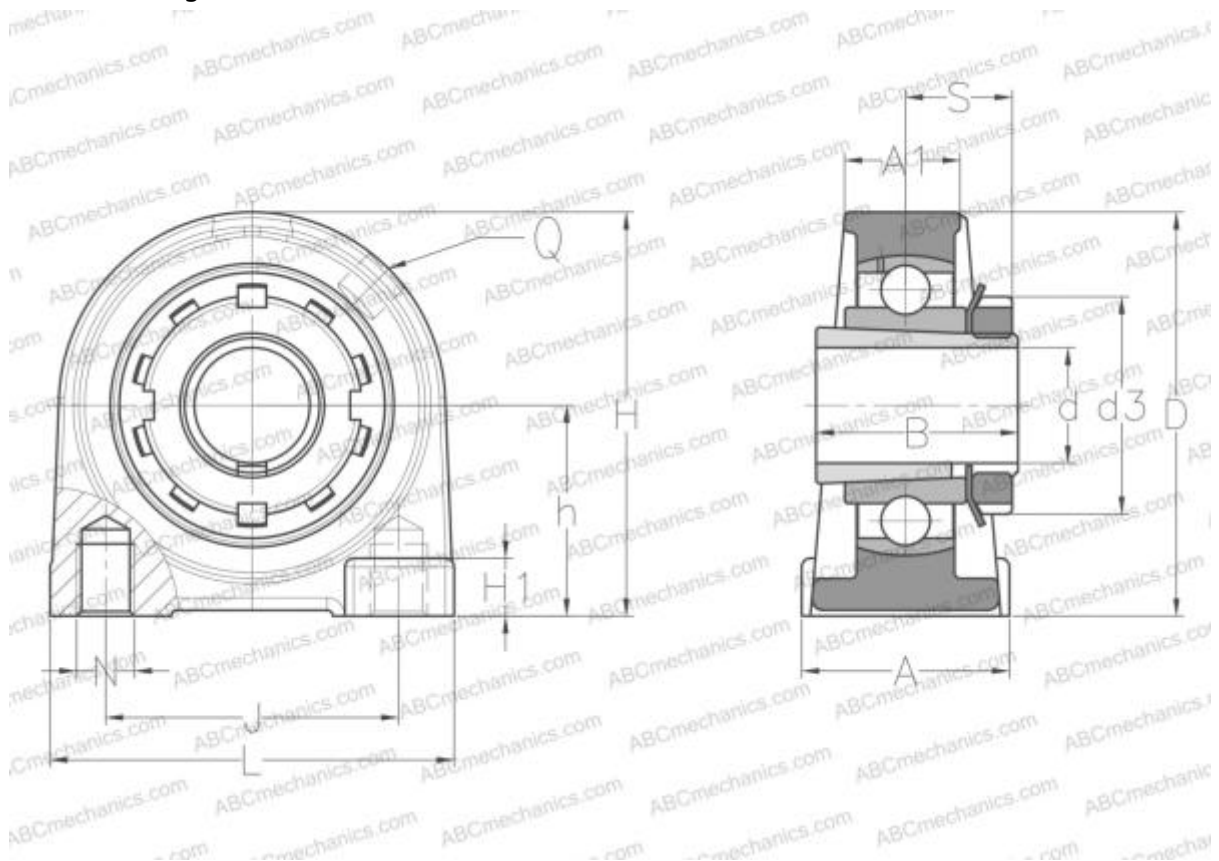

Technical specification

DIMENSIONS, MM

d	25,000
D	62,000
B	38,000
L	85,000
H	83,000
A	48,000
J	60,000
A1	25,000
H1	17,000
S	20,500
d3	45,000
h	42,900
Q	M6x1

WEIGHT, KG 1,100

Bearing	UK206 +
Housing	PG206
Adapter sleeve	H2306

MANUFACTURER

[ABC](#)

INTERCHANGE

SNR [UKPG206H](#)