

UKPG207H SNR

Ball bearing units

TYPE: Housing units, Plummer block, Narrow cast iron housing, Radial insert ball bearing with adapter sleeve, With inner ring extended on both sides, wide base

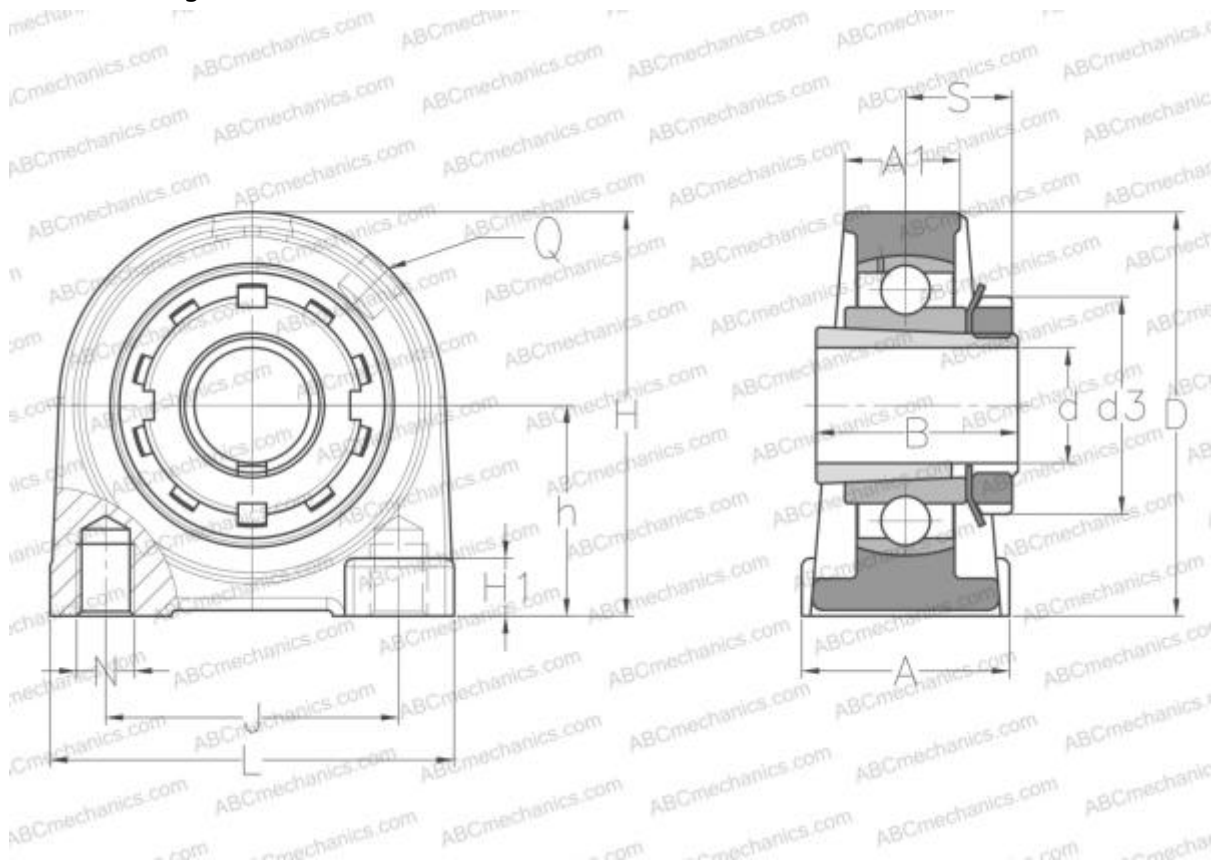

Technical specification

DIMENSIONS, MM

d	30,000
D	72,000
B	43,000
L	100,000
H	93,000
A	48,000
J	68,000
A1	27,000
H1	20,000
S	22,500
d3	52,000
h	47,600
Q	M6x1

WEIGHT, KG 1,600

Bearing	UK207 +
Housing	PG207
Adapter sleeve	H2307

MANUFACTURER

[SNR](#)

INTERCHANGE

ABC [UKPG207H](#)

CALCULATION DATA

Basic dynamic load rating, C	25,700 kN
Basic static load rating, Co	15,200 kN
Operating temperature min	-20 °C
Operating temperature max	110 °C