

UKPA205H ABC

Ball bearing units

TYPE: Housing units, Plummer block, Narrow cast iron housing, Radial insert ball bearing with adapter sleeve, With inner ring extended on both sides, massive bearing units

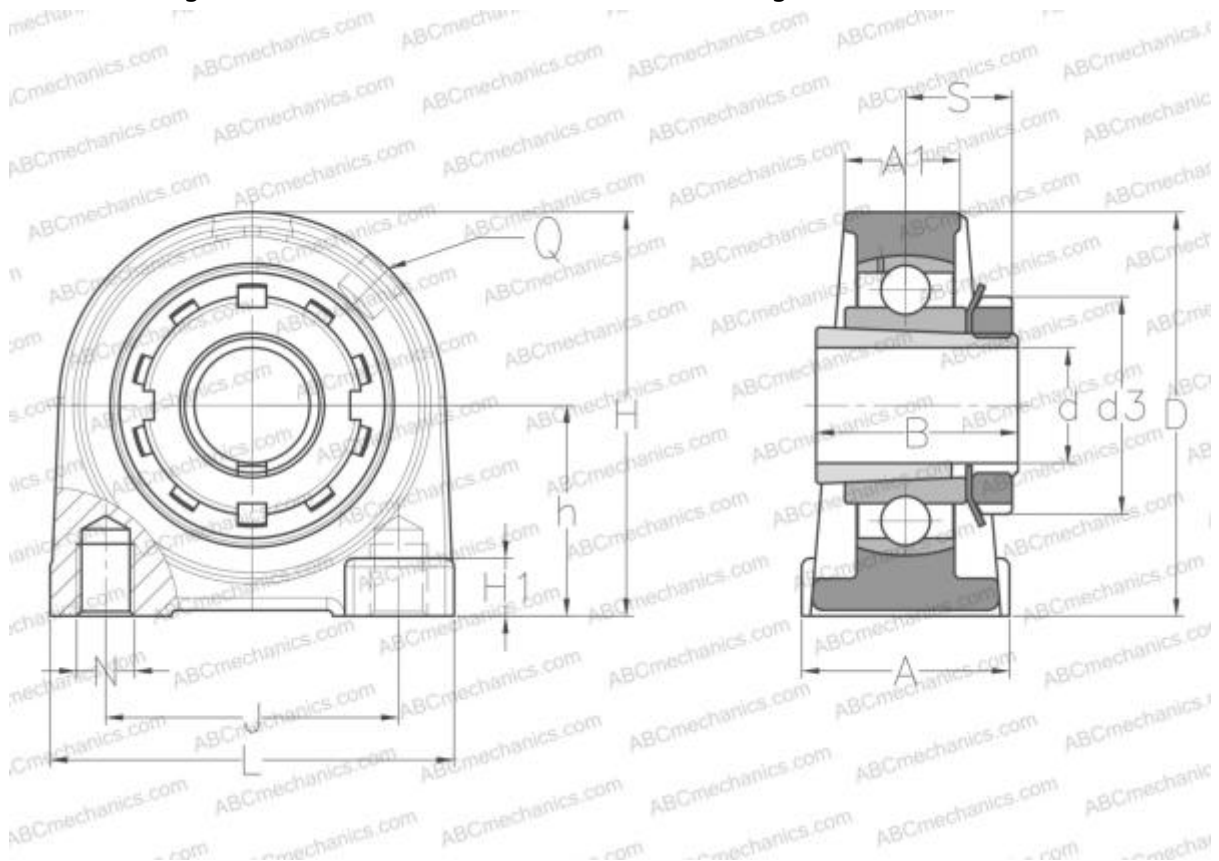

Technical specification

DIMENSIONS, MM

d	20,000
D	52,000
B	35,000
L	84,000
H	72,000
A	38,000
J	56,000
A1	23,000
H1	12,000
S	18,500
d3	38,000
h	36,500
Q	M6x1

WEIGHT, KG 0,800

Bearing	UK205 +
Housing	PA205
Adapter sleeve	H2305

MANUFACTURER

[ABC](#)

INTERCHANGE

SNR [UKPA205H](#)