

UKPA209H ABC

Ball bearing units

TYPE: Housing units, Plummer block, Narrow cast iron housing, Radial insert ball bearing with adapter sleeve, With inner ring extended on both sides, massive bearing units

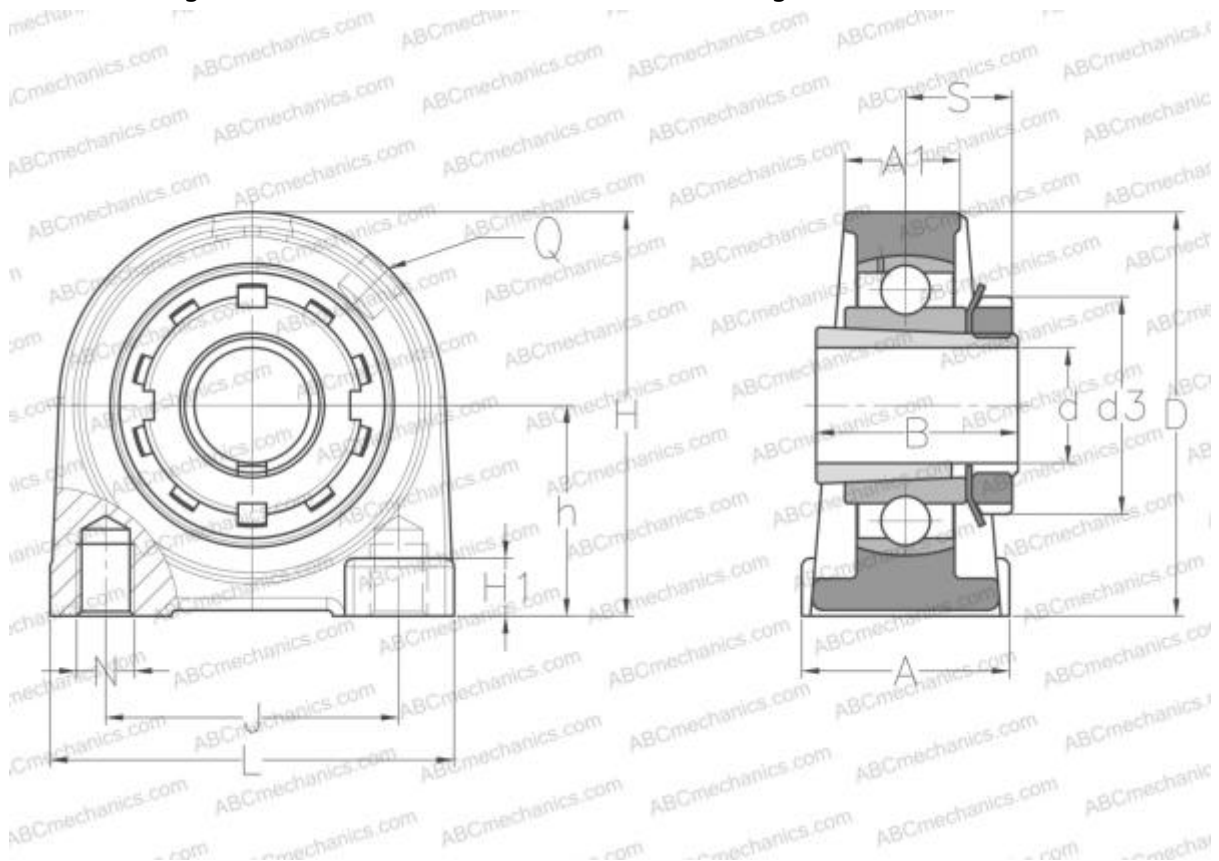

Technical specification

DIMENSIONS, MM

d	40,000
D	85,000
B	50,000
L	120,000
H	108,000
A	60,000
J	90,000
A1	32,000
H1	13,000
S	26,000
d3	65,000
h	54,200
Q	M6x1

WEIGHT, KG 2,200

Bearing	UK209 +
Housing	PA209
Adapter sleeve	H2309

MANUFACTURER

[ABC](#)

INTERCHANGE

SNR [UKPA209H](#)