

## EXFLZ202 SNR

Ball bearing units

TYPE: Housing units, Two-bolt flanged housing units, Cast iron housing, Radial insert ball bearing with eccentric locking collar, With inner ring extended on both sides, with centring rim

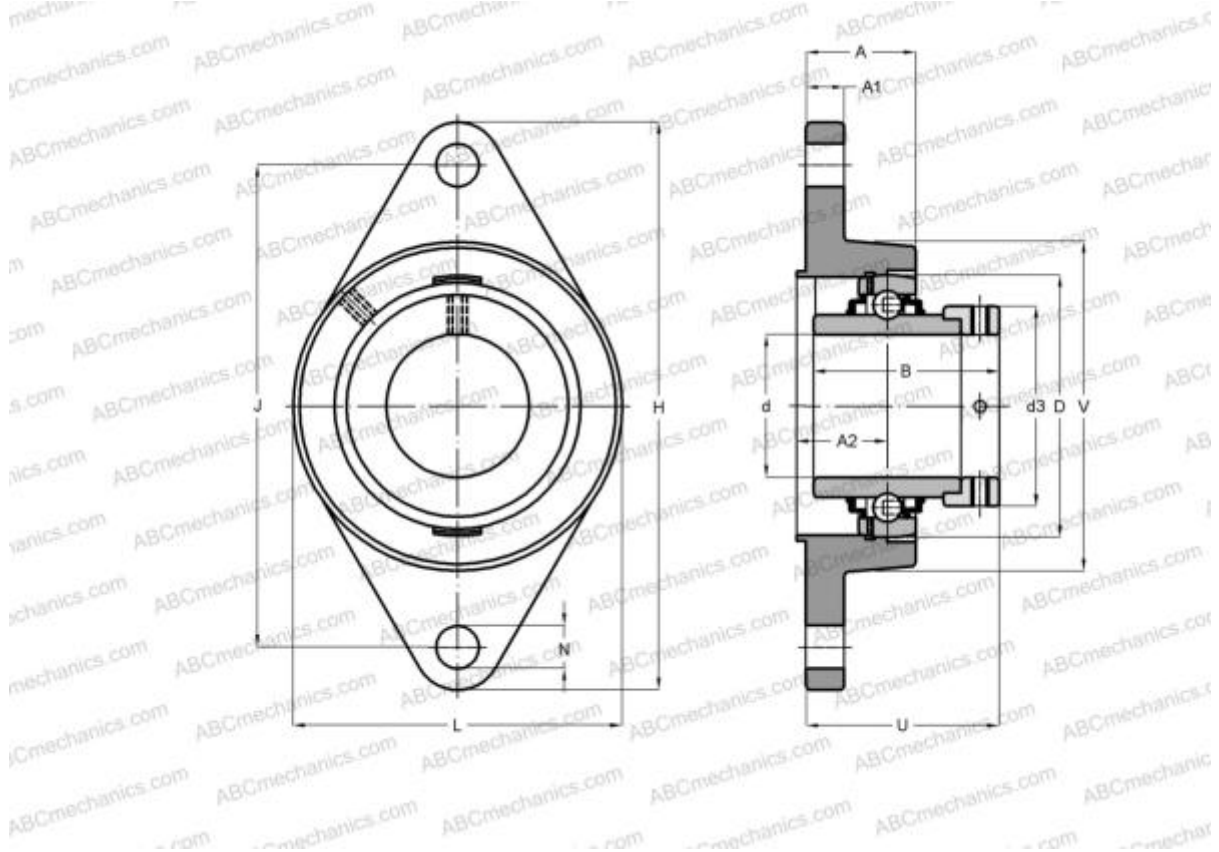

### Technical specification

#### DIMENSIONS, MM

d	15,000
D	47,000
B	43,500
L	60,500
H	112,500
A	32,000
J	90,000
A1	10,000
A2	19,000
N	11,500
S	17,000
d3	33,300
U	45,500
Z	55,000
Q	R1/8"

#### WEIGHT, KG

	0,600
Bearing	EX202
Housing	FLZ204

#### MANUFACTURER

[SNR](#)

#### INTERCHANGE

ABC	<a href="#">EXFLZ202</a>
-----	--------------------------

#### CALCULATION DATA

Basic dynamic load rating, C	12,800 kN
Basic static load rating, Co	6,650 kN
Operating temperature min	-20 °C
Operating temperature max	110 °C