

EXFLZ205 SNR

Ball bearing units

TYPE: Housing units, Two-bolt flanged housing units, Cast iron housing, Radial insert ball bearing with eccentric locking collar, With inner ring extended on both sides, with centring rim

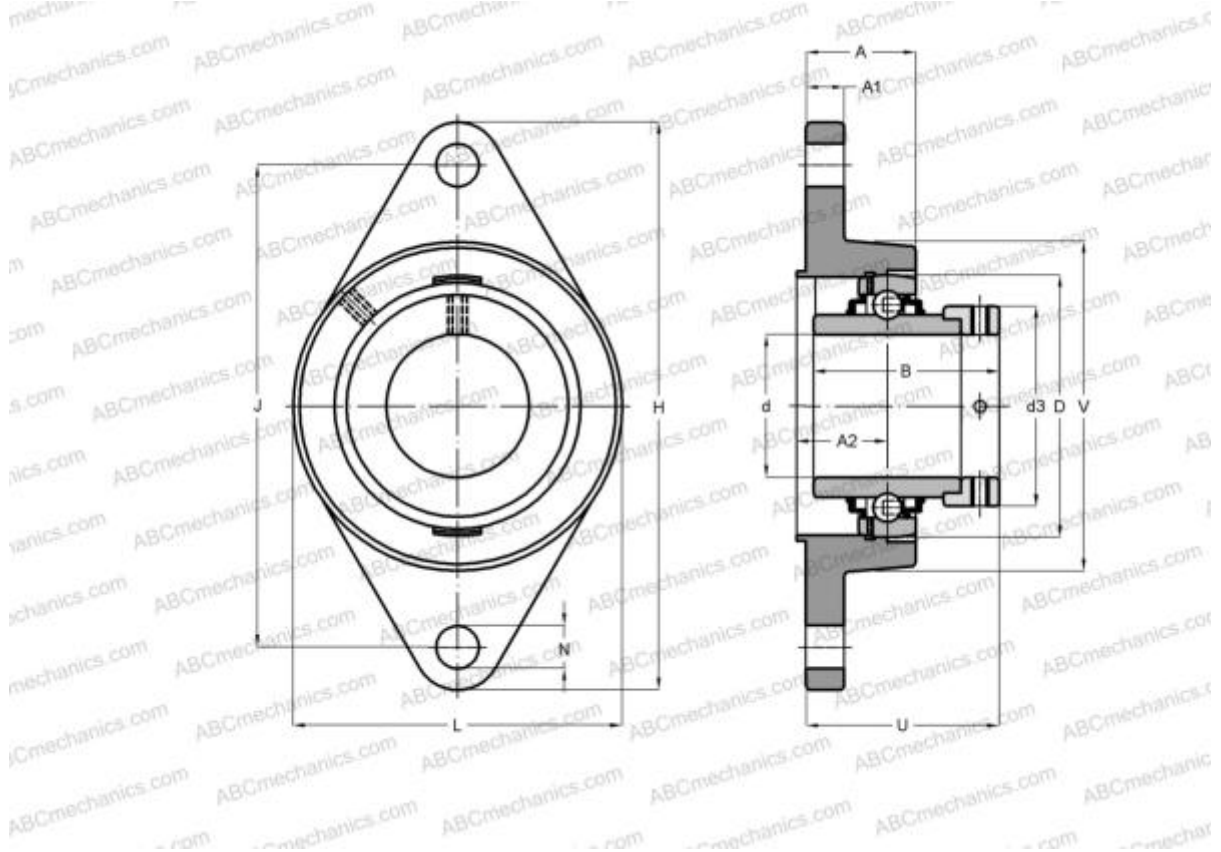

Technical specification

DIMENSIONS, MM

d	25,000
D	52,000
B	44,300
L	70,000
H	124,000
A	32,500
J	99,000
A1	12,000
A2	19,000
N	11,500
S	17,400
d3	38,100
U	45,900
Z	60,000
Q	R1/8"

WEIGHT, KG

	0,700
Bearing	EX205
Housing	FLZ205

MANUFACTURER

[SNR](#)

INTERCHANGE

ABC	EXFLZ205
INA	RCJTZ25

CALCULATION DATA

Basic dynamic load rating, C	14,000 kN
Basic static load rating, Co	7,880 kN
Operating temperature min	-20 °C
Operating temperature max	110 °C