

EST203 SNR

Ball bearing units

TYPE: Housing units, Take-up housing units, Cast iron housing, Radial insert ball bearing with eccentric locking collar, With inner ring extended at one side, for tensioning frame

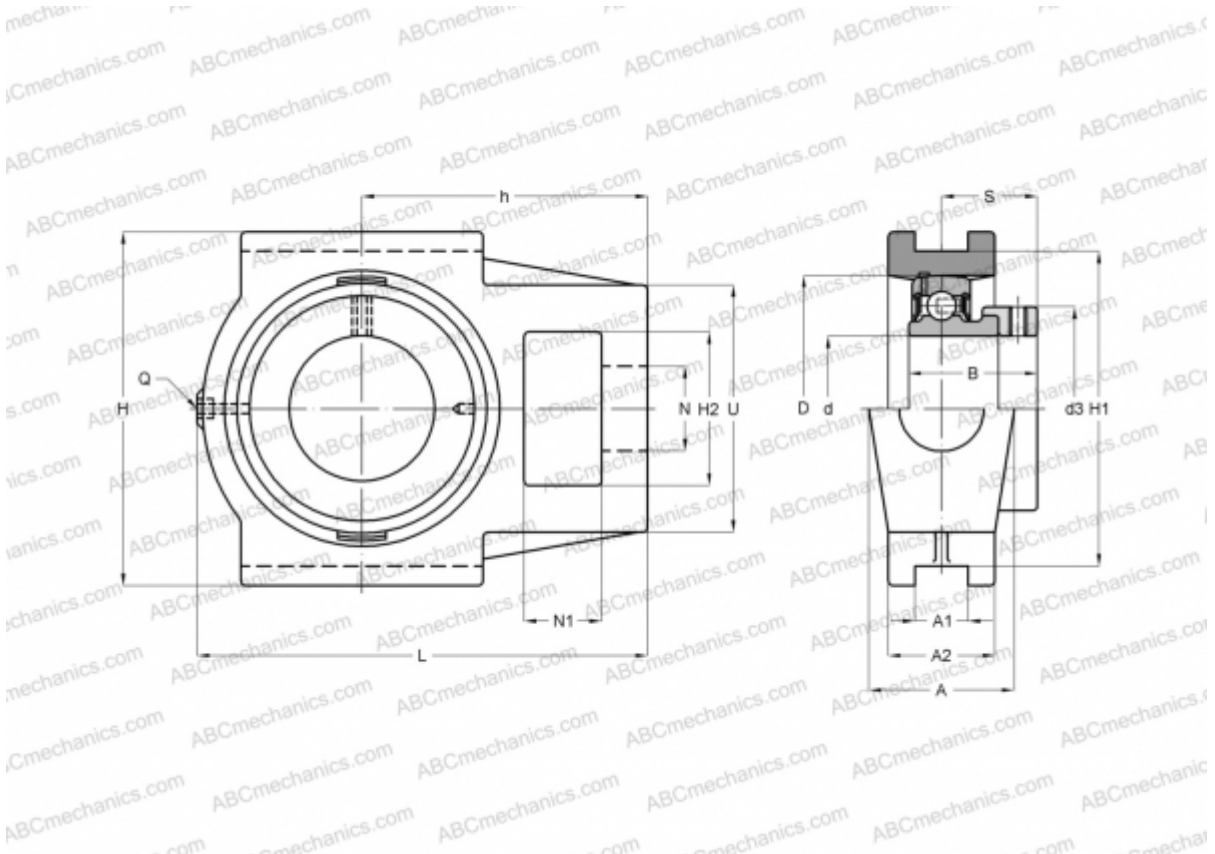

Technical specification

DIMENSIONS, MM

d	17,000
D	40,000
B	28,600
L	94,000
H	89,000
A	32,000
H2	32,000
A1	12,000
A2	21,000
H1	76,000
N	19,000
N1	16,000
S	22,100
d3	28,600
U	51,000

DIMENSIONS, MM

h	61,000
Q	M6x1

WEIGHT, KG

Bearing	ES203
Housing	T204

MANUFACTURER

[SNR](#)

INTERCHANGE

ABC	EST203
-----	------------------------

CALCULATION DATA

Basic dynamic load rating, C	9,550 kN
Basic static load rating, Co	4,780 kN
Operating temperature min	-20 °C



CALCULATION DATA

Operating temperature max

110 °C

