

EST205 ABC

Ball bearing units

TYPE: Housing units, Take-up housing units, Cast iron housing, Radial insert ball bearing with eccentric locking collar, With inner ring extended at one side, for tensioning frame

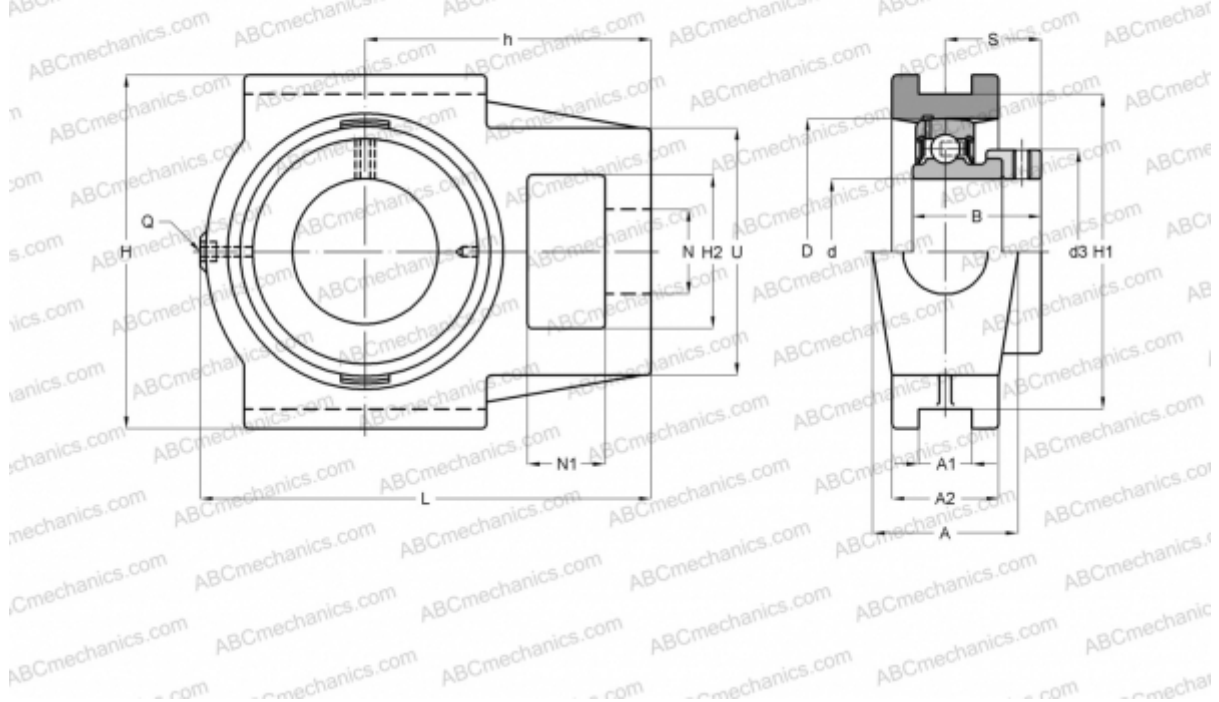

Technical specification

DIMENSIONS, MM

d	25,000
D	52,000
B	30,900
L	97,000
H	89,000
A	32,000
H2	32,000
A1	12,000
A2	24,000
H1	76,000
N	19,000
N1	16,000
S	23,400
d3	38,100
U	51,000

DIMENSIONS, MM

h	62,000
Q	M6x1

WEIGHT, KG

Bearing	ES205
Housing	T205

MANUFACTURER

[ABC](#)

INTERCHANGE

INA	PTUE25
SNR	EST205