

EXT202 SNR

Ball bearing units

TYPE: Housing units, Take-up housing units, Cast iron housing, Radial insert ball bearing with eccentric locking collar, With inner ring extended on both sides, for tensioning frame

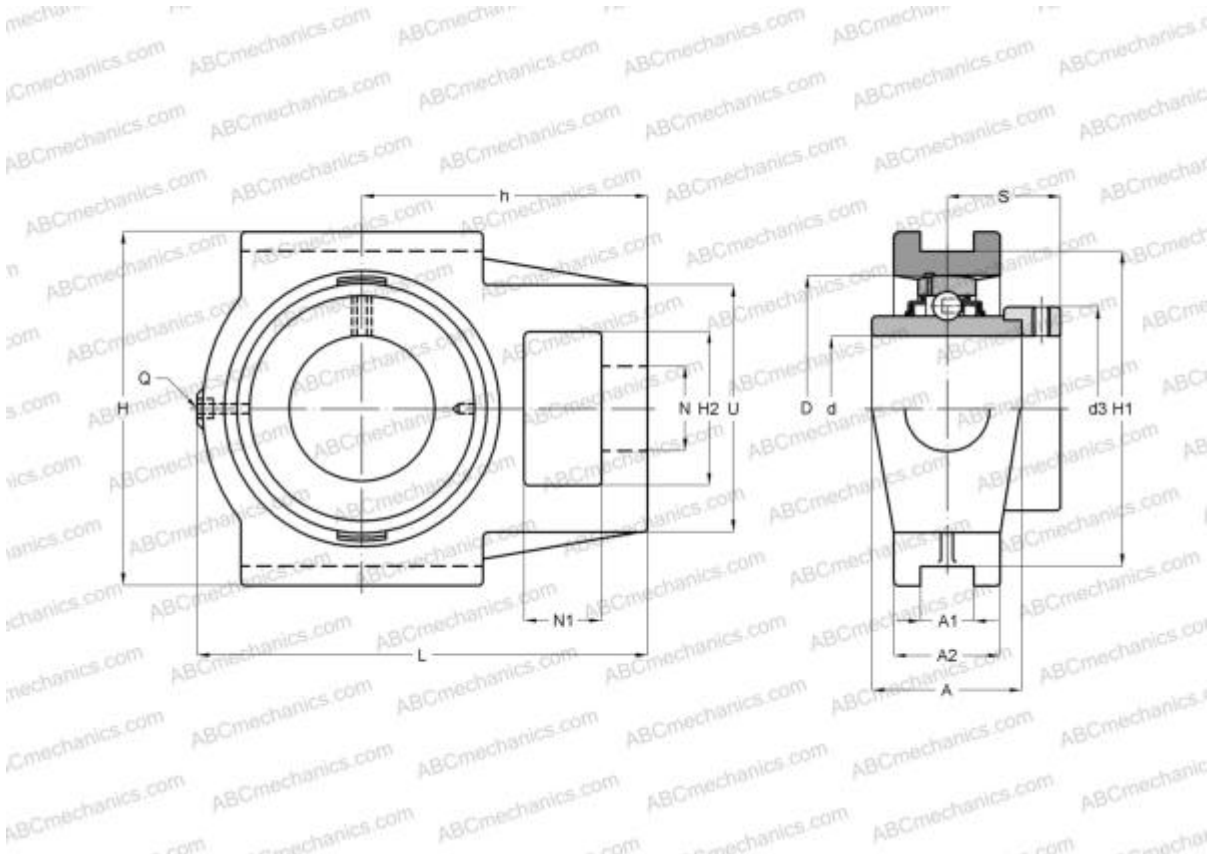

Technical specification

DIMENSIONS, MM

d	15,000
D	47,000
B	43,500
L	94,000
H	89,000
A	32,000
H2	32,000
A1	12,000
A2	21,000
H1	76,000
N	19,000
N1	16,000
S	26,500
d3	33,300
U	51,000

DIMENSIONS, MM

h	61,000
Q	M6x1

WEIGHT, KG

Bearing	0,800
Housing	EX202
	T204

MANUFACTURER

[SNR](#)

INTERCHANGE

ABC	EXT202
-----	------------------------

CALCULATION DATA

Basic dynamic load rating, C	12,800 kN
Basic static load rating, Co	6,650 kN
Operating temperature min	-20 °C



CALCULATION DATA

Operating temperature max

110 °C

