

UST203 ABC

Ball bearing units

TYPE: Housing units, Take-up housing units, Cast iron housing, Radial insert ball bearing with grub screws in inner ring, With inner ring extended at one side, for tensioning frame

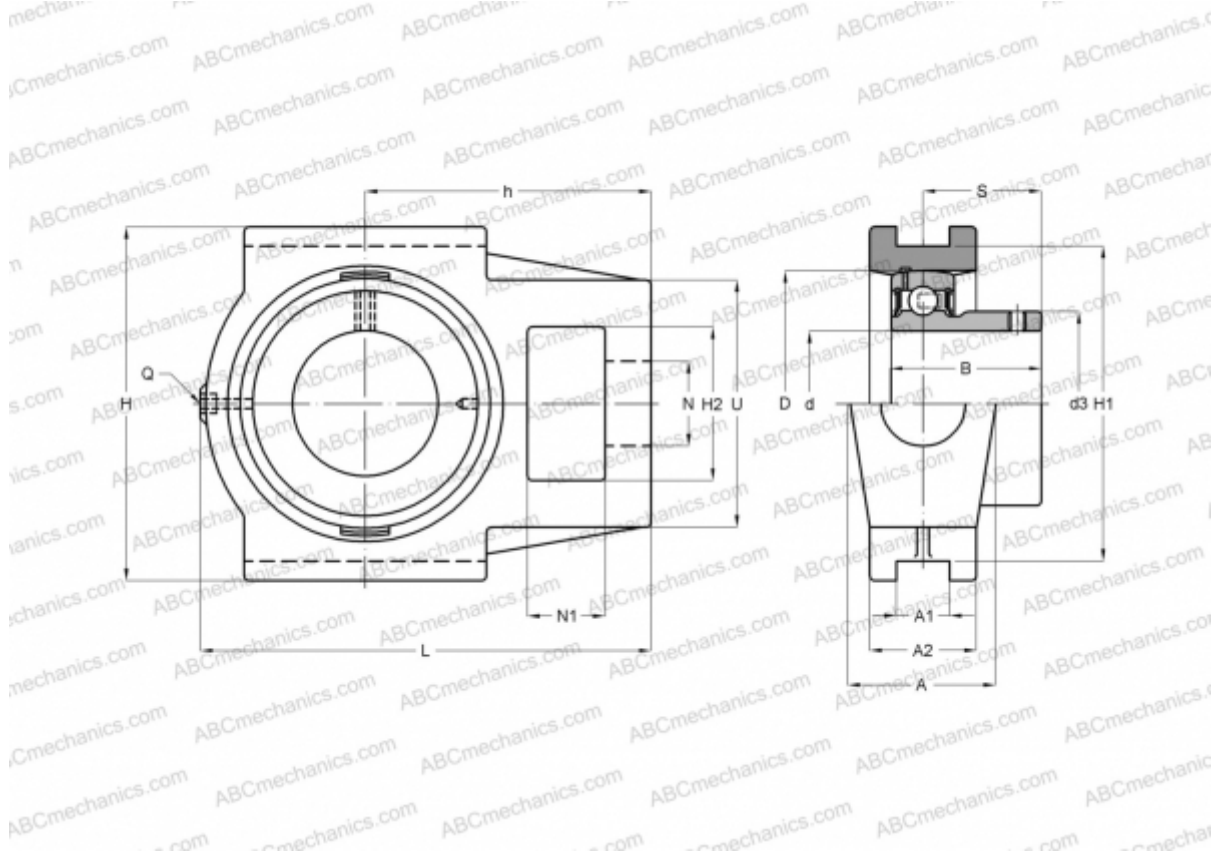

Technical specification

DIMENSIONS, MM

d	17,000
D	40,000
B	22,000
L	94,000
H	89,000
A	32,000
H2	32,000
A1	12,000
A2	21,000
H1	76,000
N	19,000
N1	16,000
S	16,000
U	51,000
h	61,000

DIMENSIONS, MM

Q	M6x1
---	------

WEIGHT, KG

Bearing	US203
Housing	T204

MANUFACTURER

[ABC](#)

INTERCHANGE

SNR	UST203
-----	------------------------