

UCT202 SNR

Ball bearing units

TYPE: Housing units, Take-up housing units, Cast iron housing, Radial insert ball bearing with grub screws in inner ring, With inner ring extended on both sides, for tensioning frame

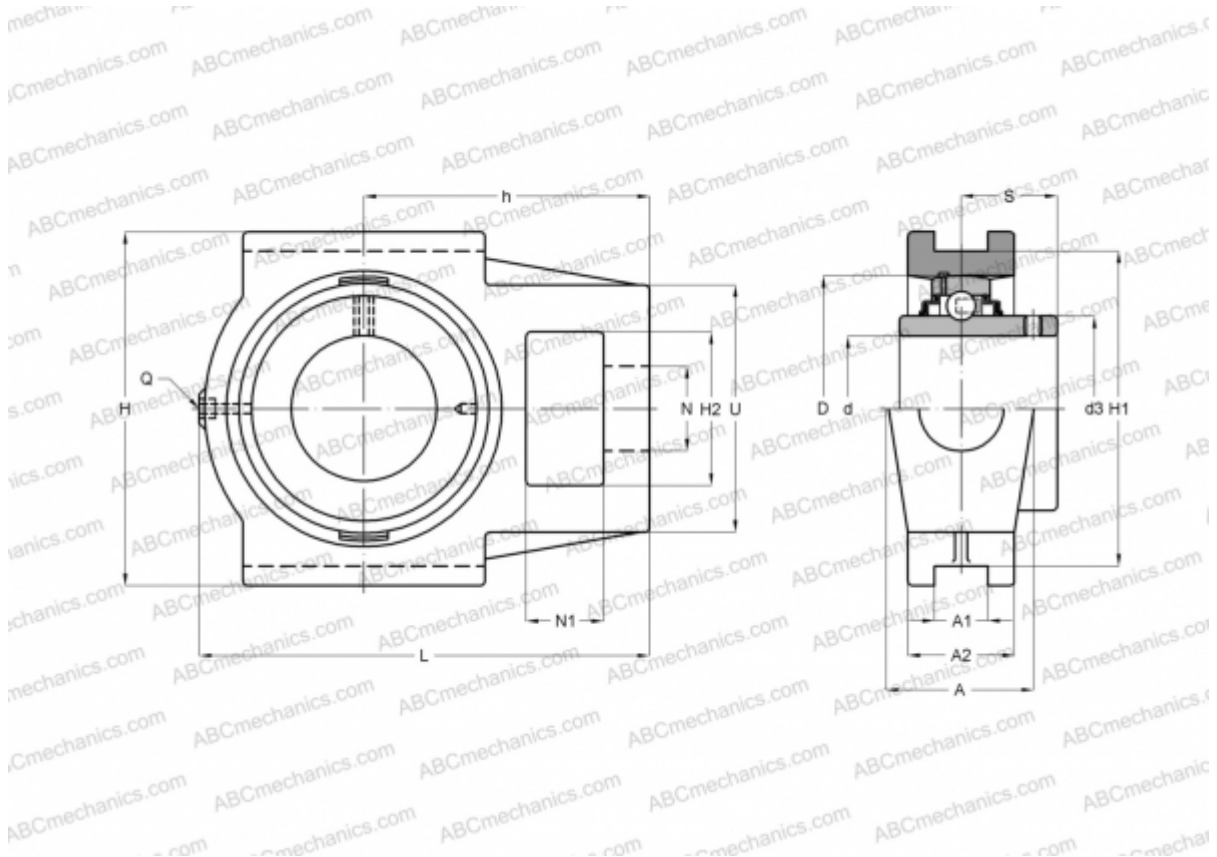

Technical specification

DIMENSIONS, MM

d	15,000
D	47,000
B	31,000
L	94,000
H	89,000
A	32,000
H2	32,000
A1	12,000
A2	21,000
H1	76,000
N	19,000
N1	16,000
S	18,300
U	51,000
h	61,000

DIMENSIONS, MM

Q	M6x1
---	------

WEIGHT, KG

Bearing	UC202
Housing	T204

MANUFACTURER

[SNR](#)

INTERCHANGE

ABC	UCT202
ASAHI	UCT 202
SLB	UCT202
FYH	UCT202
NTN	UCT 202 D1

CALCULATION DATA

Basic dynamic load rating, C	12,800 kN
Basic static load rating, Co	6,650 kN
Operating temperature min	-20 °C
Operating temperature max	110 °C