

EST203+WB SNR

Ball bearing units

TYPE: Housing units, Take-up housing units, Cast iron and sheet steel housing, Radial insert ball bearing with eccentric locking collar, With inner ring extended at one side

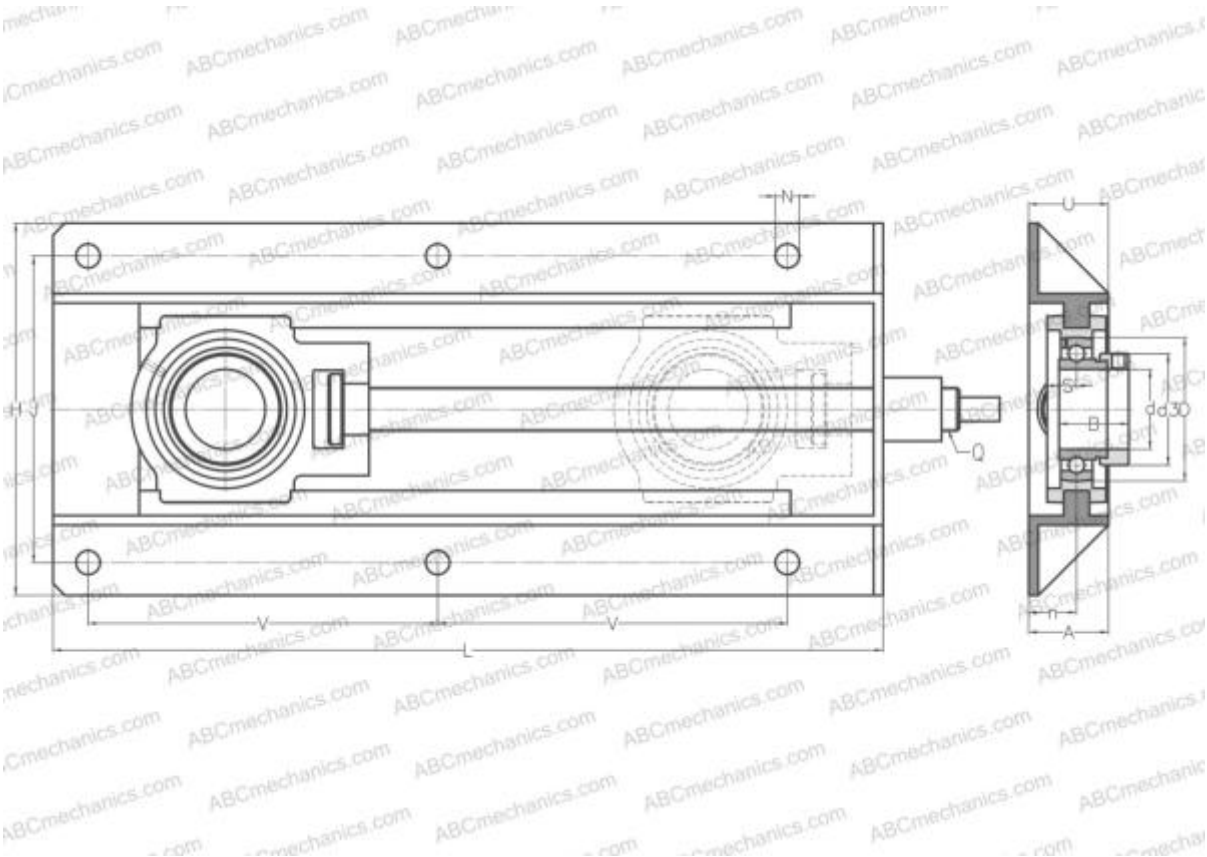

Technical specification

DIMENSIONS, MM

d	17,000
D	40,000
B	28,600
L	317,000
H	199,000
A	50,000
J	154,000
N	12,000
S	6,500
d3	28,600
U	51,100
V	117,000
I	83,000
n	29,000

WEIGHT, KG

	5,100
Bearing	ES203
Housing	T204+WB205

MANUFACTURER

[SNR](#)

INTERCHANGE

ABC	EST203+WB
-----	---------------------------

CALCULATION DATA

Basic dynamic load rating, C	9,550 kN
Basic static load rating, Co	4,780 kN
Operating temperature min	-20 °C
Operating temperature max	110 °C