

## EXT202+WB ABC

Ball bearing units

TYPE: Housing units, Take-up housing units, Cast iron and sheet steel housing, Radial insert ball bearing with eccentric locking collar, With inner ring extended on both sides

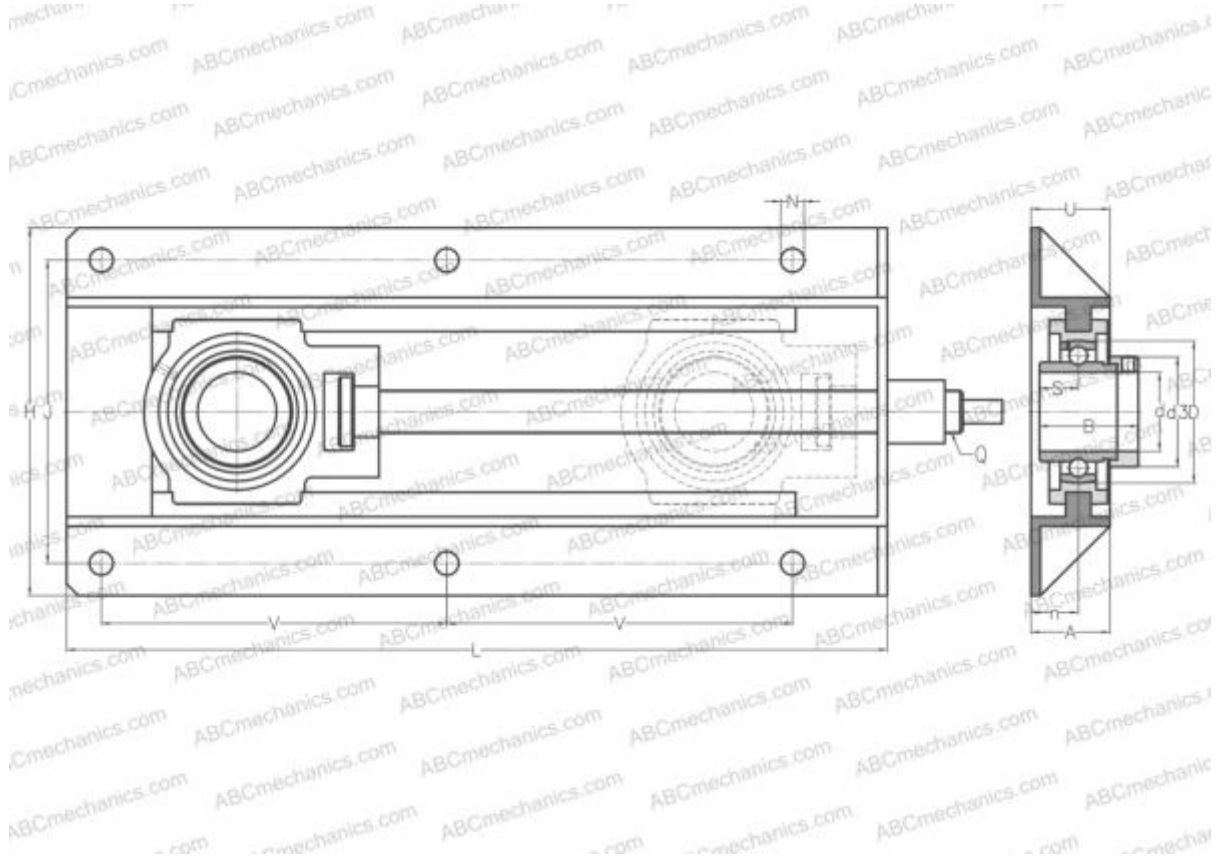

### Technical specification

#### DIMENSIONS, MM

d	15,000
D	47,000
B	43,500
L	317,000
H	199,000
A	50,000
J	154,000
N	12,000
S	17,000
d3	33,300
U	55,500
V	117,000
I	83,000
n	29,000

#### WEIGHT, KG

	5,300
Bearing	EX202
Housing	T204+WB205

#### MANUFACTURER

[ABC](#)

#### INTERCHANGE

SNR	<a href="#">EXT202+WB</a>
-----	---------------------------