

EXT204+WB SNR

Ball bearing units

TYPE: Housing units, Take-up housing units, Cast iron and sheet steel housing, Radial insert ball bearing with eccentric locking collar, With inner ring extended on both sides

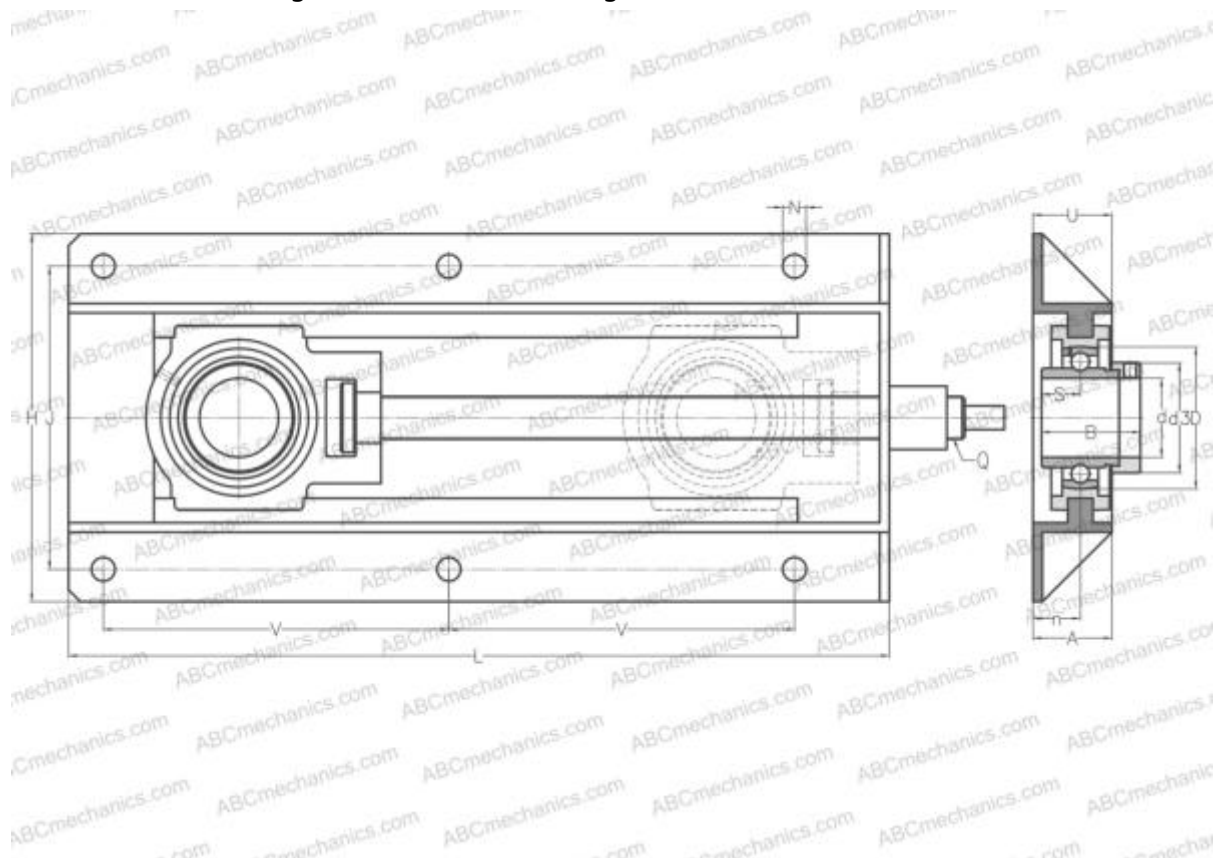

Technical specification

DIMENSIONS, MM

d	20,000
D	47,000
B	43,500
L	317,000
H	199,000
A	50,000
J	154,000
N	12,000
S	17,000
d3	33,300
U	55,500
V	117,000
I	83,000
n	29,000

WEIGHT, KG

	5,200
Bearing	EX204
Housing	T204+WB205

MANUFACTURER

[SNR](#)

INTERCHANGE

ABC	EXT204+WB
-----	---------------------------

CALCULATION DATA

Basic dynamic load rating, C	12,800 kN
Basic static load rating, Co	6,650 kN
Operating temperature min	-20 °C
Operating temperature max	110 °C