

EXT205+WB SNR

Ball bearing units

TYPE: Housing units, Take-up housing units, Cast iron and sheet steel housing, Radial insert ball bearing with eccentric locking collar, With inner ring extended on both sides

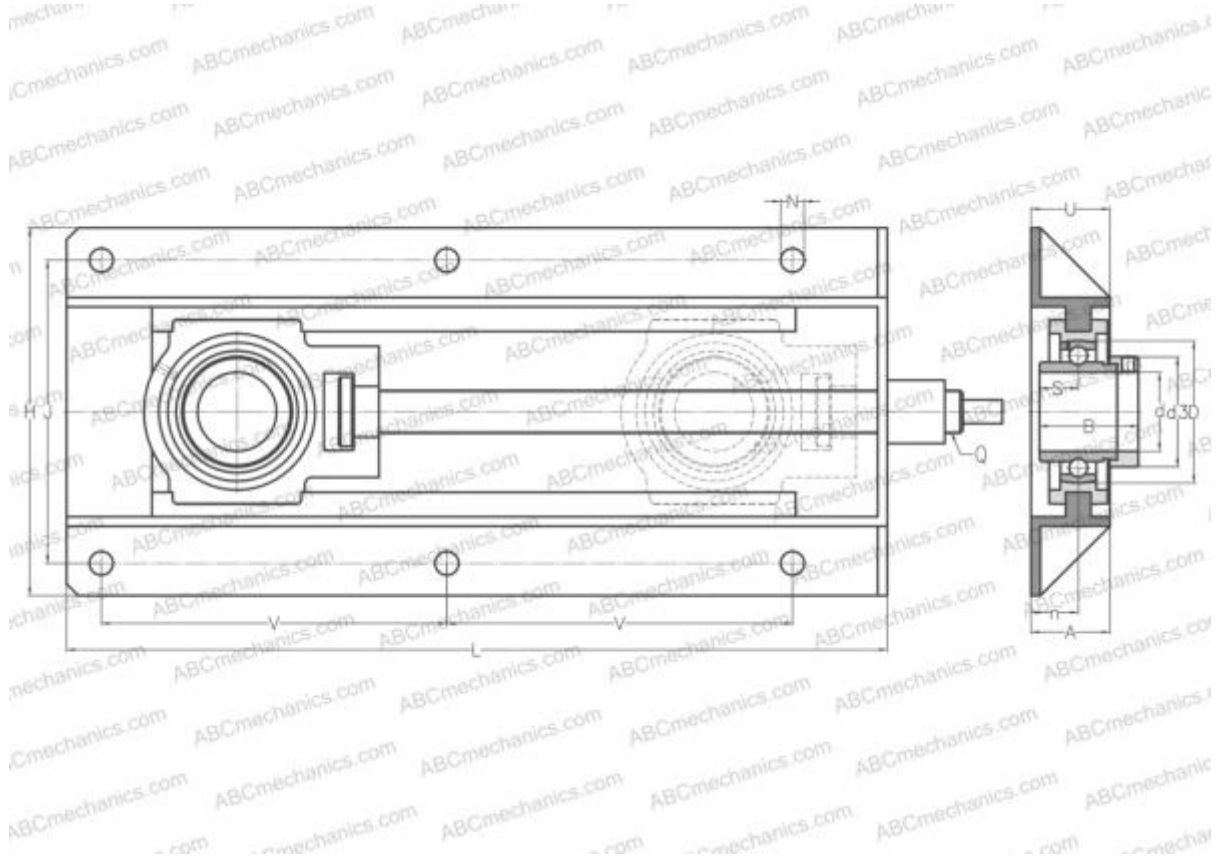

Technical specification

DIMENSIONS, MM

d	25,000
D	52,000
B	44,300
L	317,000
H	199,000
A	50,000
J	154,000
N	12,000
S	17,400
d3	38,100
U	55,900
V	117,000
I	83,000
n	29,000

WEIGHT, KG

	5,300
Bearing	EX205
Housing	T205+WB205

MANUFACTURER

[SNR](#)

INTERCHANGE

ABC	EXT205+WB
-----	---------------------------

CALCULATION DATA

Basic dynamic load rating, C	14,000 kN
Basic static load rating, Co	7,880 kN
Operating temperature min	-20 °C
Operating temperature max	110 °C