

## UST202+WB SNR

Ball bearing units

TYPE: Housing units, Take-up housing units, Cast iron and sheet steel housing, Radial insert ball bearing with grub screws in inner ring, With inner ring extended at one side

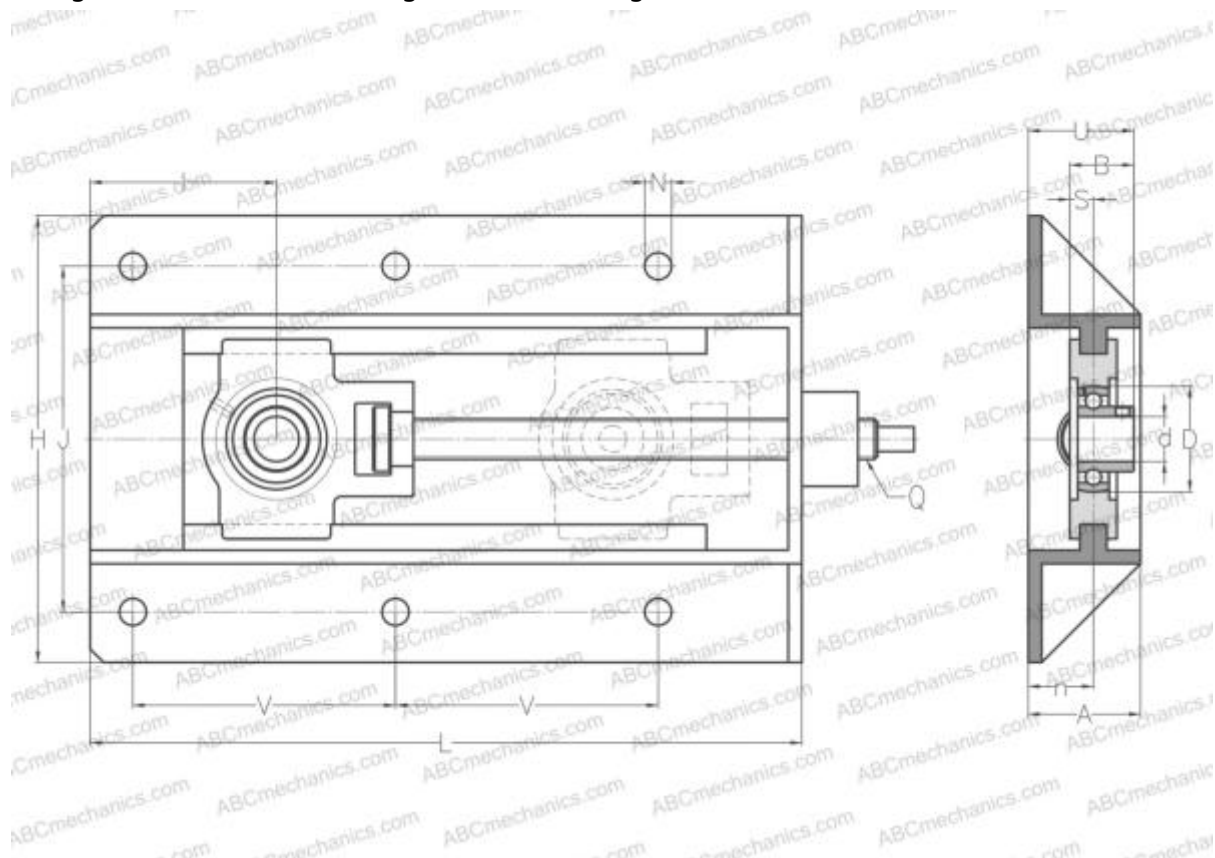

### Technical specification

#### DIMENSIONS, MM

d	15,000
D	40,000
B	22,000
L	317,000
H	199,000
A	50,000
J	154,000
N	12,000
S	6,000
U	45,000
V	117,000
I	83,000
n	29,000

Bearing	US202
Housing	T204+WB205

#### MANUFACTURER

[SNR](#)

#### INTERCHANGE

ABC	<a href="#">UST202+WB</a>
-----	---------------------------

#### CALCULATION DATA

Basic dynamic load rating, C	9,550 kN
Basic static load rating, Co	4,780 kN
Operating temperature min	-20 °C
Operating temperature max	110 °C

WEIGHT, KG	5,100
------------	-------