

## UST205+WB ABC

Ball bearing units

TYPE: Housing units, Take-up housing units, Cast iron and sheet steel housing, Radial insert ball bearing with grub screws in inner ring, With inner ring extended at one side

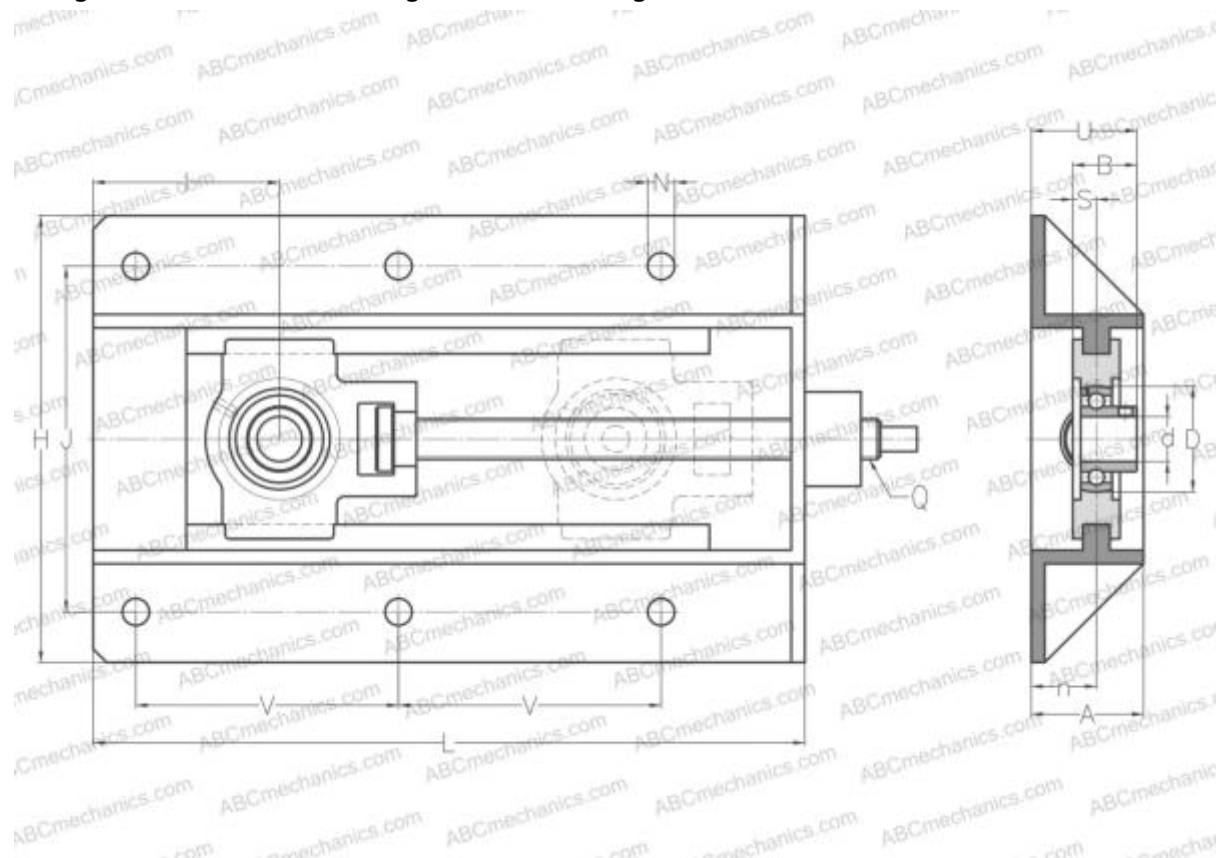

### Technical specification

#### DIMENSIONS, MM

d	25,000
D	52,000
B	27,000
L	317,000
H	199,000
A	50,000
J	154,000
N	12,000
S	7,500
U	48,500
V	117,000
I	83,000
n	29,000

Bearing	US205
Housing	T205+WB205

**MANUFACTURER** [ABC](#)

**INTERCHANGE**  
SNR [UST205+WB](#)

**WEIGHT, KG** 5,200