

UCT203+WB ABC

Ball bearing units

TYPE: Housing units, Take-up housing units, Cast iron and sheet steel housing, Radial insert ball bearing with grub screws in inner ring, With inner ring extended on both sides

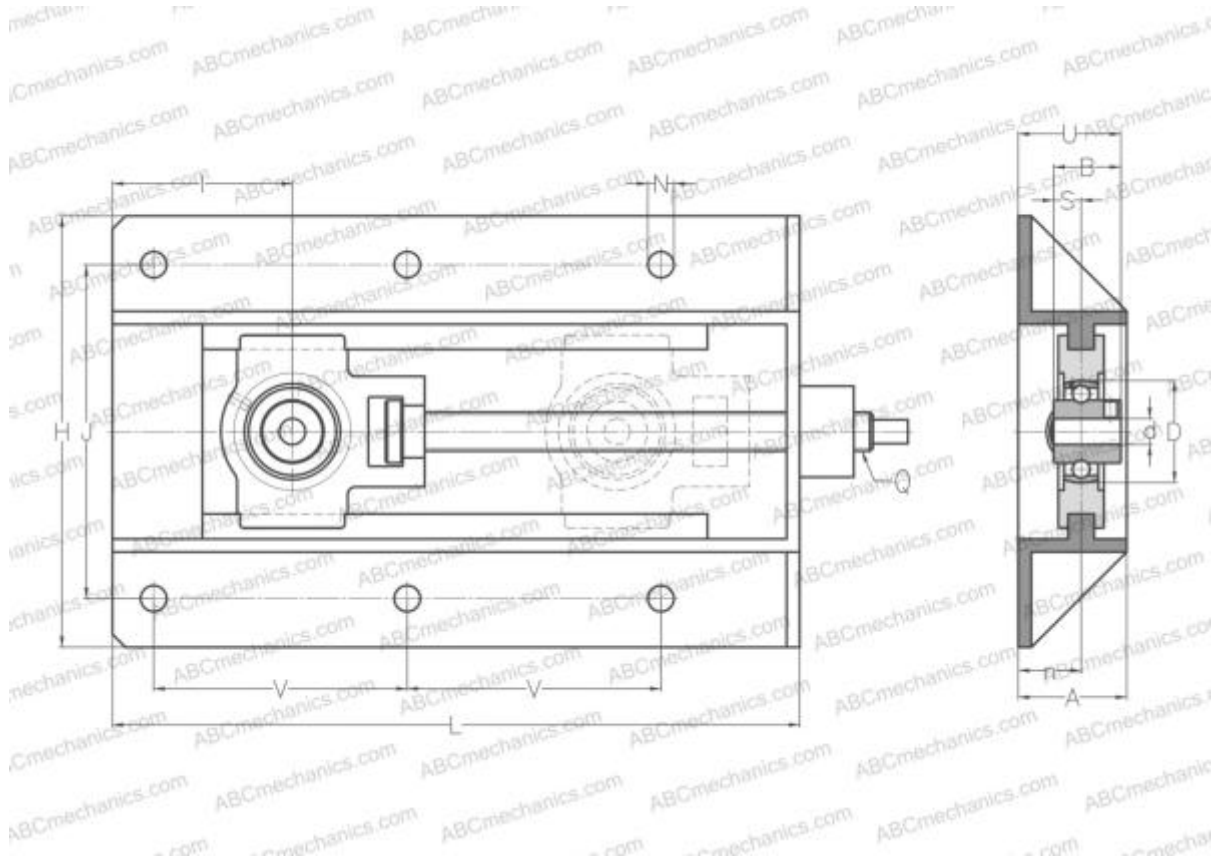

Technical specification

DIMENSIONS, MM

d	17,000
D	47,000
B	31,000
L	317,000
H	199,000
A	50,000
J	154,000
N	12,000
S	12,700
U	47,300
V	117,000
I	83,000
n	29,000

WEIGHT, KG 5,200

Bearing	UC203
Housing	T204+WB205

MANUFACTURER [ABC](#)

INTERCHANGE
SNR [UCT203+WB](#)