

## UKT207H+WB SNR

Ball bearing units

TYPE: Housing units, Take-up housing units, Cast iron and sheet steel housing, Radial insert ball bearing with adapter sleeve, With inner ring extended on both sides

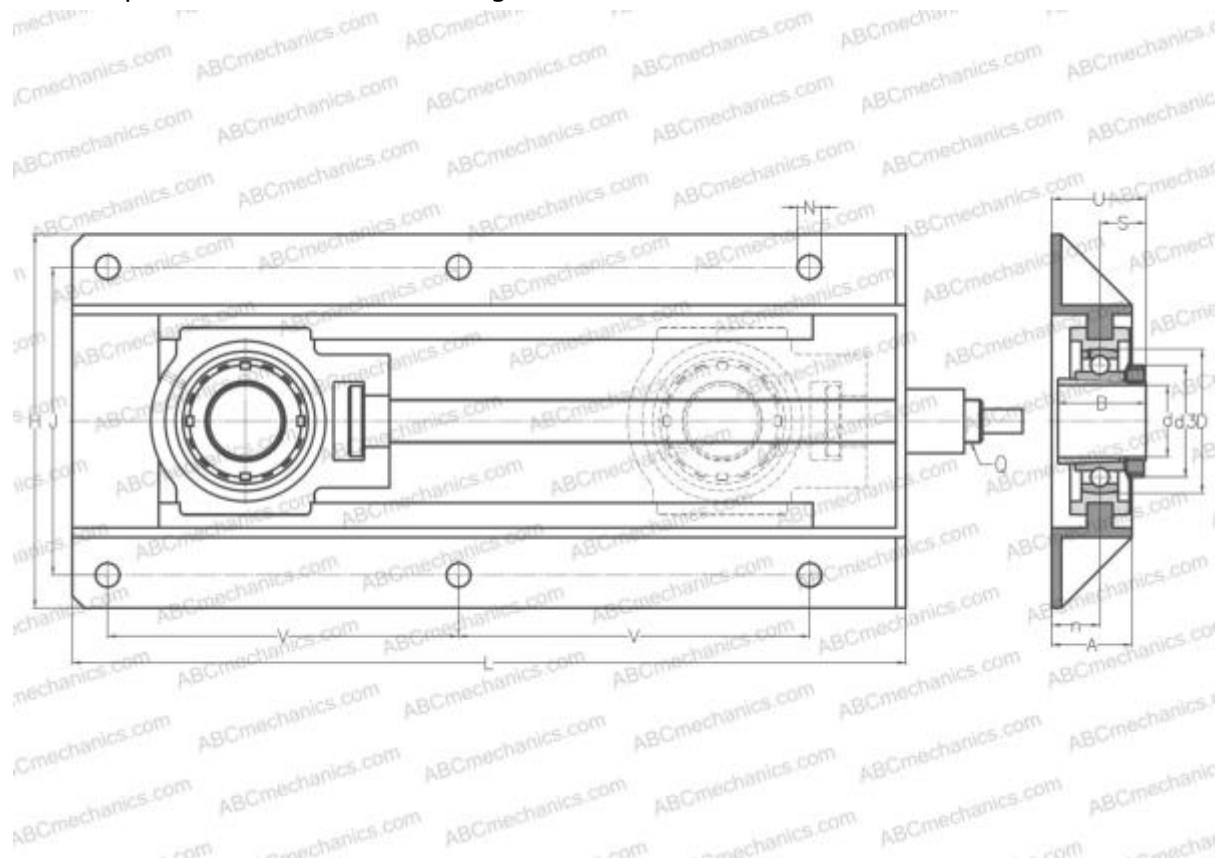

### Technical specification

#### DIMENSIONS, MM

d	30,000
D	72,000
B	43,000
L	429,000
H	212,000
A	50,000
J	166,000
N	12,000
S	22,500
d3	52,000
U	52,500
V	173,000
l	99,000
n	30,000

#### WEIGHT, KG

	8,400
Bearing	UK207 +
Housing	T207+WB207
Adapter sleeve	H2307

#### MANUFACTURER

[SNR](#)

#### INTERCHANGE

ABC	<a href="#">UKT207H+WB</a>
-----	----------------------------

#### CALCULATION DATA

Basic dynamic load rating, C	25,700 kN
Basic static load rating, Co	15,200 kN
Operating temperature min	-20 °C
Operating temperature max	110 °C