

UKT209H+WB SNR

Ball bearing units

TYPE: Housing units, Take-up housing units, Cast iron and sheet steel housing, Radial insert ball bearing with adapter sleeve, With inner ring extended on both sides

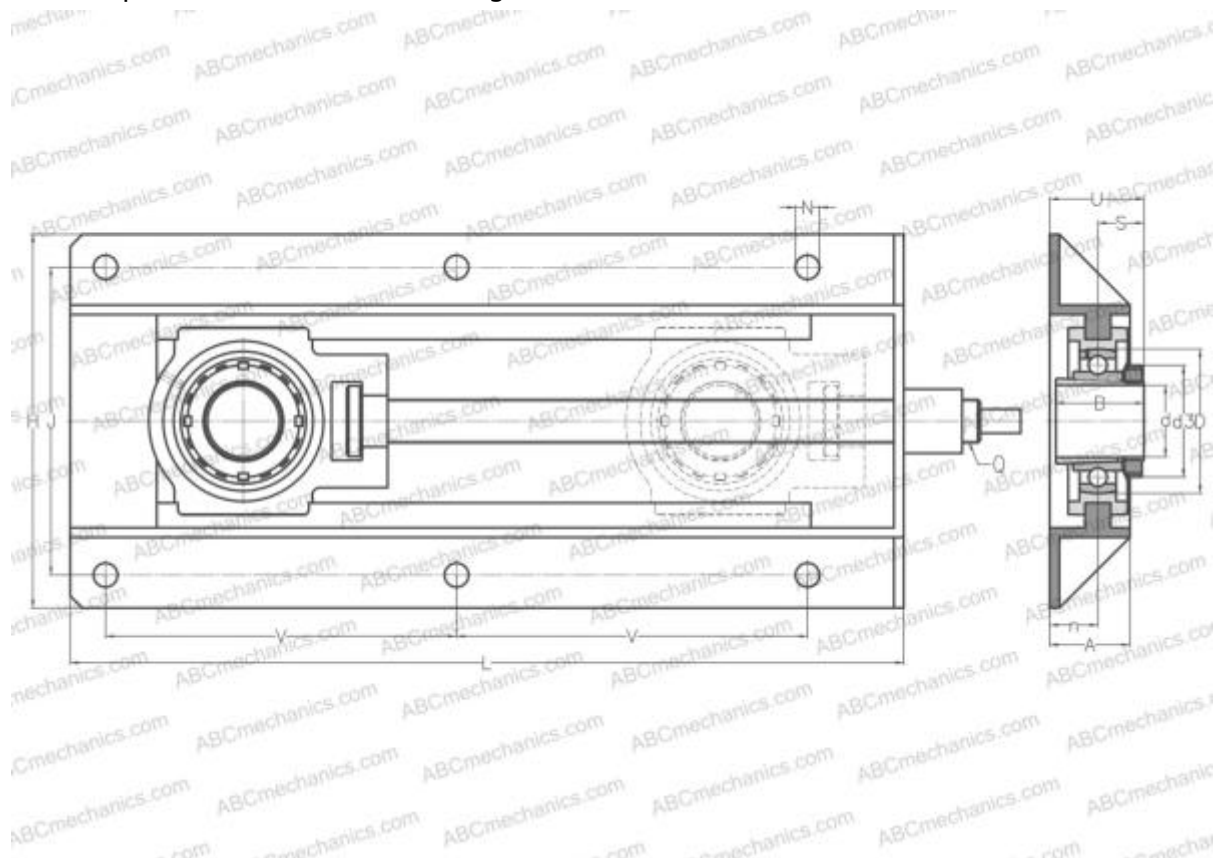

Technical specification

DIMENSIONS, MM

d	40,000
D	85,000
B	50,000
L	520,000
H	233,000
A	50,000
J	192,000
N	15,000
S	26,000
d3	65,000
U	56,000
V	219,000
l	108,000
n	30,000

WEIGHT, KG

	11,900
Bearing	UK209 +
Housing	T209+WB210
Adapter sleeve	H2309

MANUFACTURER

[SNR](#)

INTERCHANGE

ABC [UKT209H+WB](#)

CALCULATION DATA

Basic dynamic load rating, C	31,850 kN
Basic static load rating, Co	20,800 kN
Operating temperature min	-20 °C
Operating temperature max	110 °C