

## ESSP202 SNR

Ball bearing units

TYPE: Housing units, Conveyor belt tensioner unit, Radial insert ball bearing with eccentric locking collar, With inner ring extended at one side

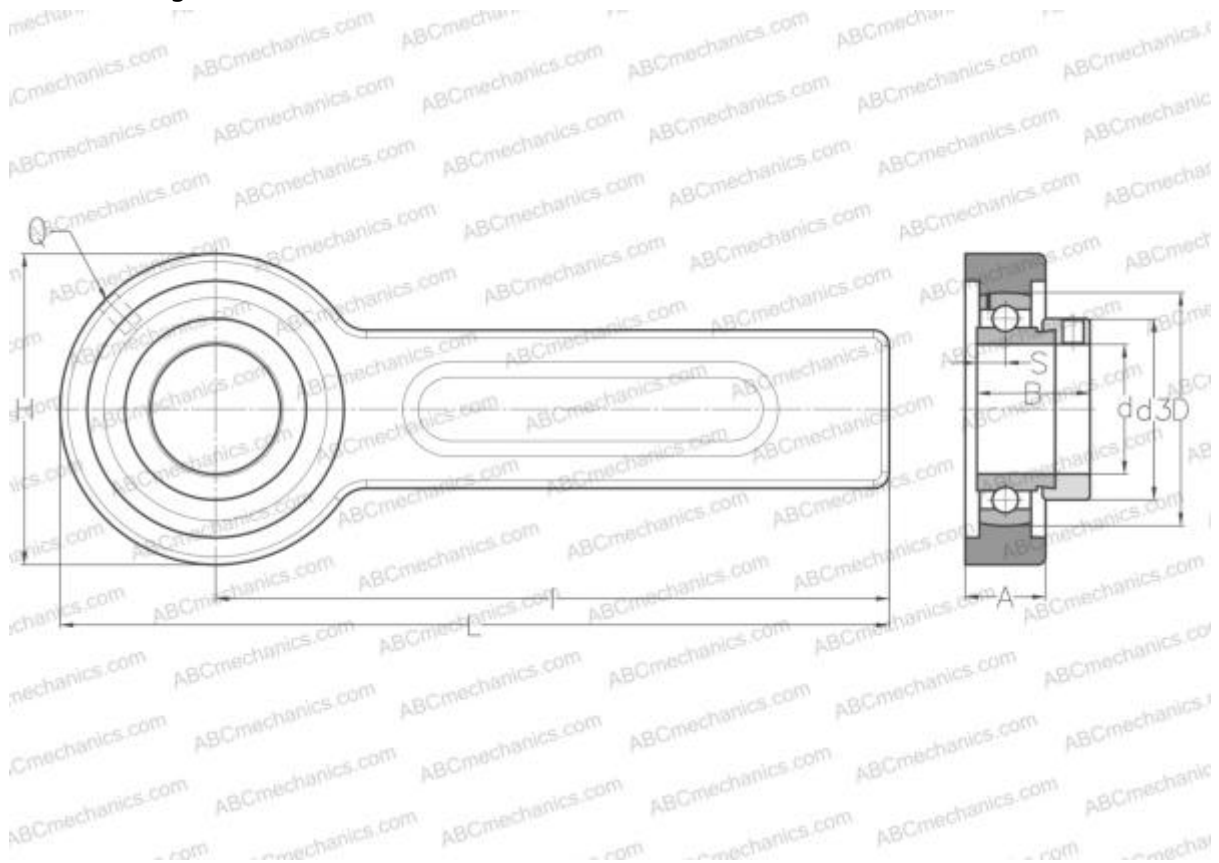

### Technical specification

#### DIMENSIONS, MM

d	15,000
D	40,000
B	28,600
L	264,000
H	78,000
A	21,000
H1	41,000
S	6,500
I	225,000
Q	R1/8"

#### WEIGHT, KG

	1,600
Bearing	ES202
Housing	03-205/40

#### MANUFACTURER

[SNR](#)

#### INTERCHANGE

ABC

[ESSP202](#)

#### CALCULATION DATA

Basic dynamic load rating, C	9,550 kN
Basic static load rating, Co	4,780 kN
Operating temperature min	-20 °C
Operating temperature max	110 °C