

ESSP205 ABC

Ball bearing units

TYPE: Housing units, Conveyor belt tensioner unit, Radial insert ball bearing with eccentric locking collar, With inner ring extended at one side

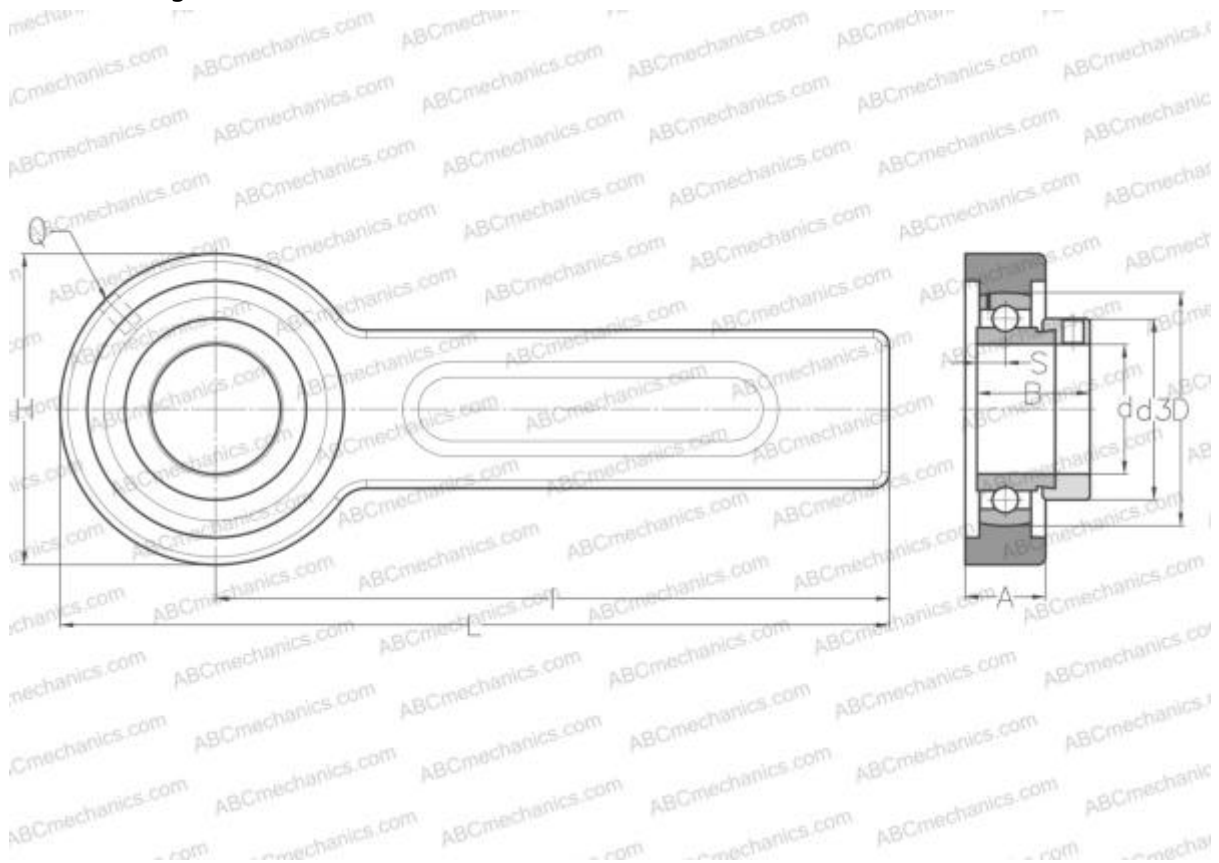

Technical specification

DIMENSIONS, MM

d	25,000
D	52,000
B	30,900
L	264,000
H	78,000
A	21,000
H1	41,000
S	7,500
I	225,000
Q	R1/8"

WEIGHT, KG 1,700

Bearing	ES205
Housing	03-205/52

MANUFACTURER

[ABC](#)

INTERCHANGE

SNR [ESSP205](#)