

USSP202 SNR

Ball bearing units

TYPE: Housing units, Conveyor belt tensioner unit, Radial insert ball bearing with grub screws in inner ring, With inner ring extended at one side

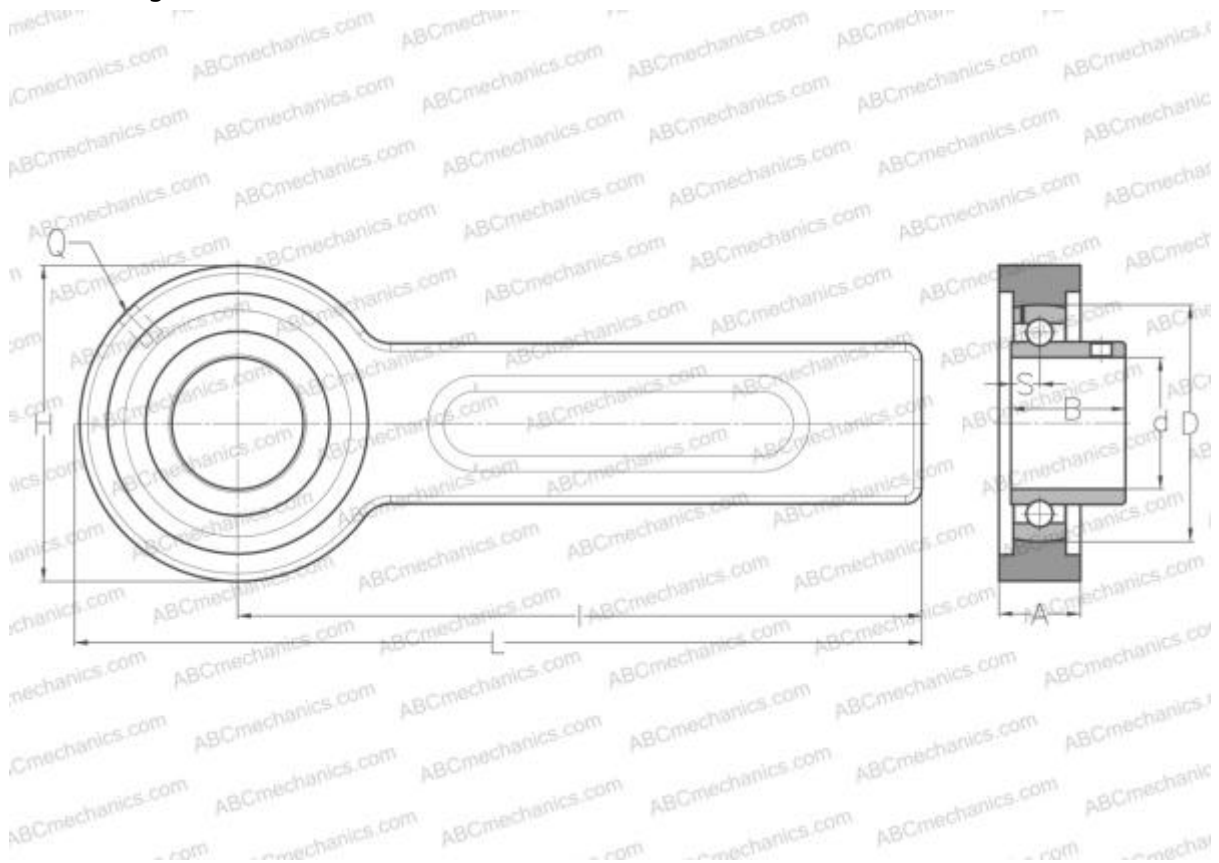

Technical specification

DIMENSIONS, MM

d	15,000
D	40,000
B	22,000
L	264,000
H	78,000
A	21,000
H1	41,000
S	6,000
d3	24,600
I	225,000
Q	R1/8"

WEIGHT, KG 1,600

Bearing US202

Housing 03-205/40

MANUFACTURER

[SNR](#)

INTERCHANGE

ABC [USSP202](#)

CALCULATION DATA

Basic dynamic load rating, C	9,550 kN
Basic static load rating, Co	4,780 kN
Operating temperature min	-20 °C
Operating temperature max	110 °C