

USSP205 ABC

Ball bearing units

TYPE: Housing units, Conveyor belt tensioner unit, Radial insert ball bearing with grub screws in inner ring, With inner ring extended at one side

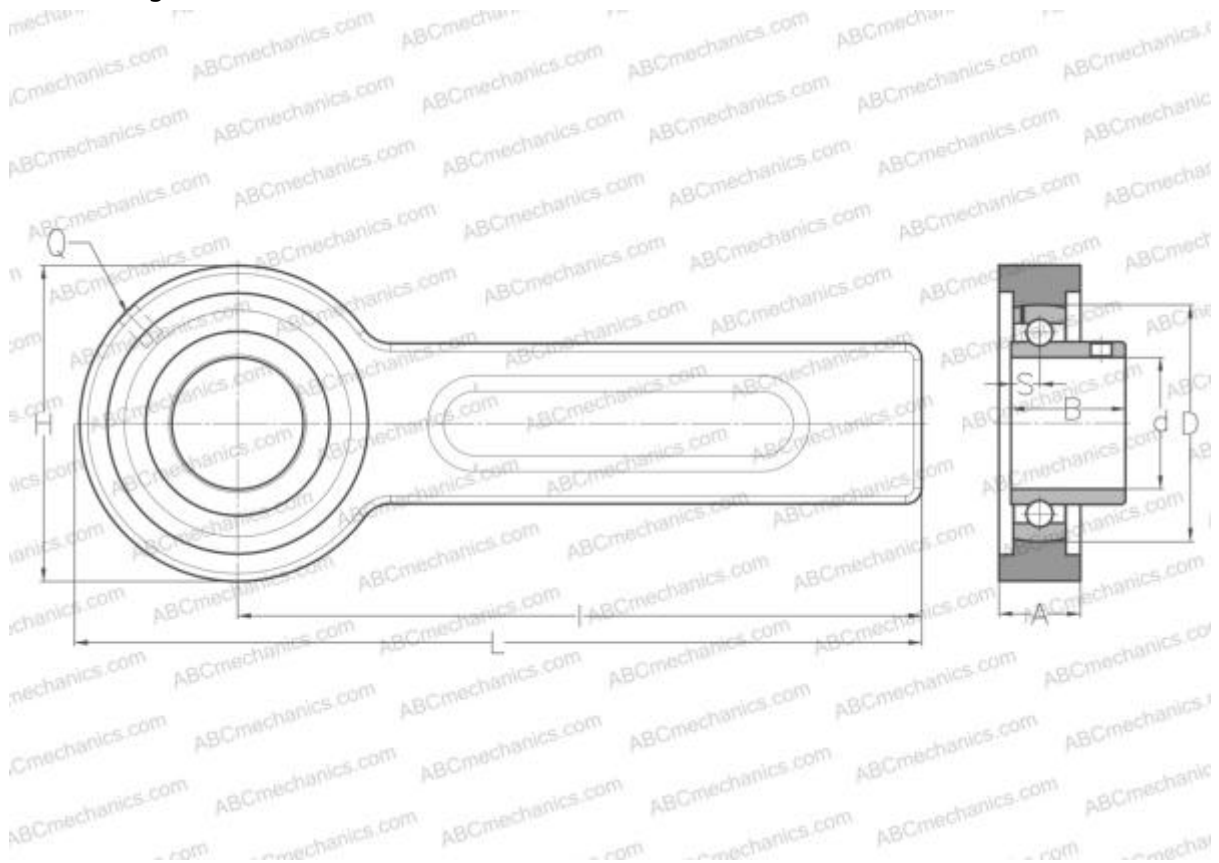

Technical specification

DIMENSIONS, MM

d	25,000
D	52,000
B	27,000
L	264,000
H	78,000
A	21,000
H1	41,000
S	7,500
d3	34,000
I	225,000
Q	R1/8"

WEIGHT, KG

	1,700
Bearing	US205

Housing

03-205/52

MANUFACTURER

[ABC](#)

INTERCHANGE

SNR

[USSP205](#)