

USSP205 SNR

Ball bearing units

TYPE: Housing units, Conveyor belt tensioner unit, Radial insert ball bearing with grub screws in inner ring, With inner ring extended at one side

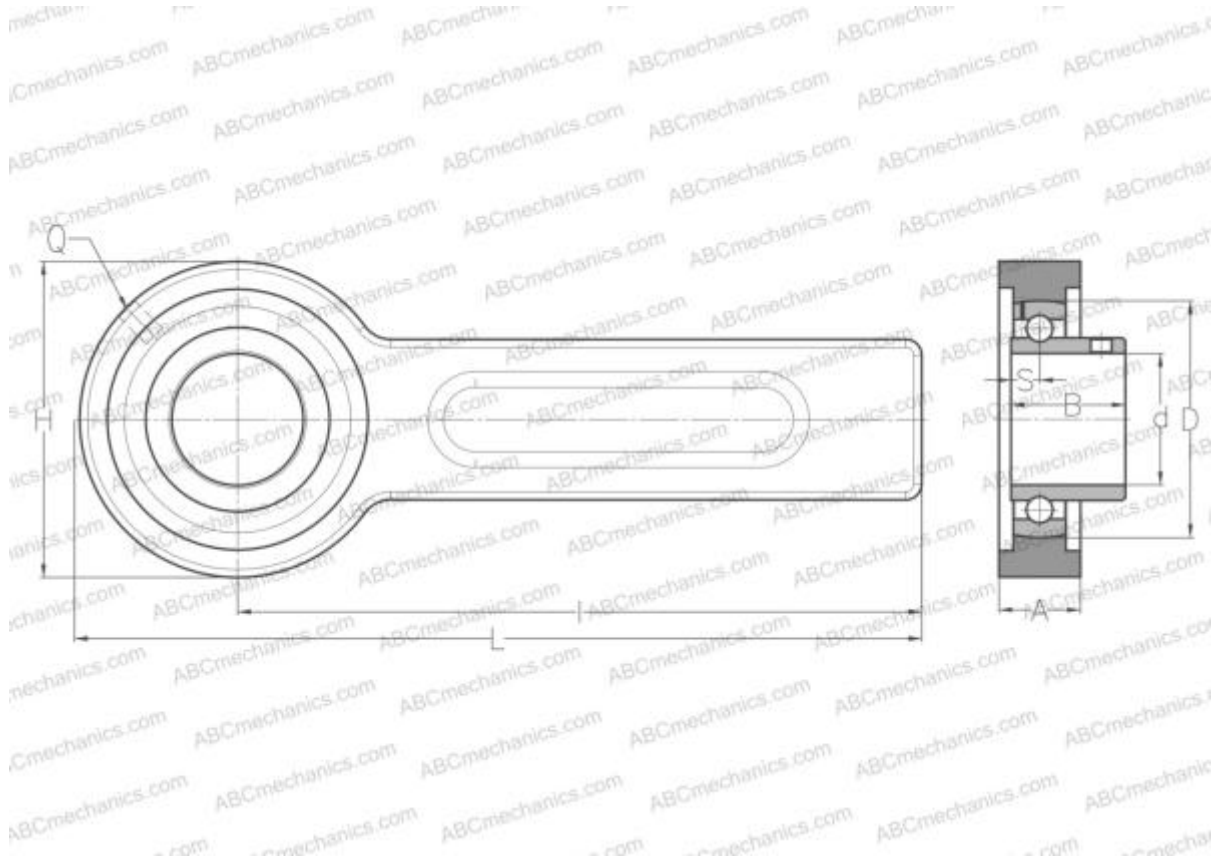

Technical specification

DIMENSIONS, MM

d	25,000
D	52,000
B	27,000
L	264,000
H	78,000
A	21,000
H1	41,000
S	7,500
d3	34,000
I	225,000
Q	R1/8"

WEIGHT, KG 1,700

Bearing US205

Housing 03-205/52

MANUFACTURER

[SNR](#)

INTERCHANGE

ABC [USSP205](#)

CALCULATION DATA

Basic dynamic load rating, C	14,000 kN
Basic static load rating, Co	7,880 kN
Operating temperature min	-20 °C
Operating temperature max	110 °C