

UCSP204 SNR

Ball bearing units

TYPE: Housing units, Conveyor belt tensioner unit, Radial insert ball bearing with grub screws in inner ring, With inner ring extended on both sides

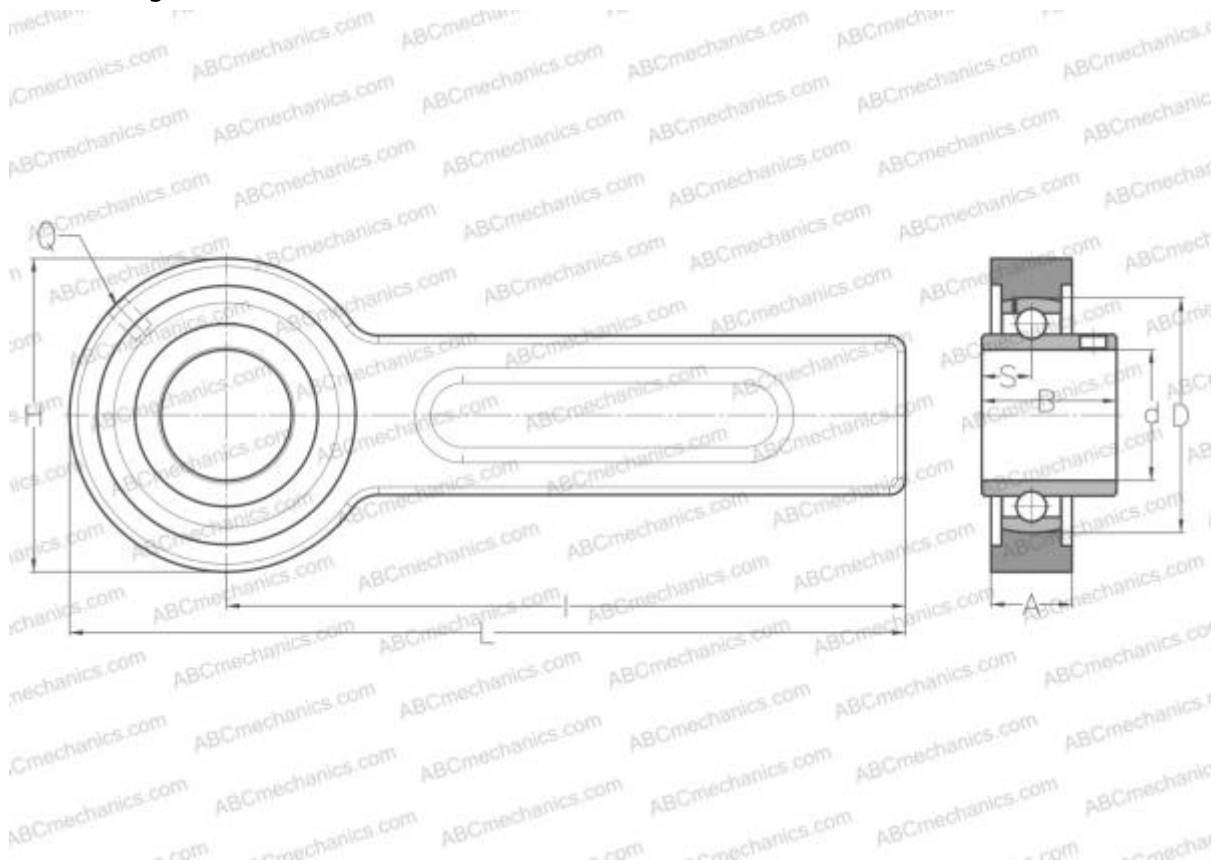

Technical specification

DIMENSIONS, MM

d	20,000
D	47,000
B	31,000
L	264,000
H	78,000
A	21,000
H1	41,000
S	12,700
d3	29,000
I	225,000
Q	R1/8"

WEIGHT, KG 1,700

Bearing UC204

Housing 03-205/47

MANUFACTURER [SNR](#)

INTERCHANGE

ABC [UCSP204](#)

CALCULATION DATA

Basic dynamic load rating, C	12,800 kN
Basic static load rating, Co	6,650 kN
Operating temperature min	-20 °C
Operating temperature max	110 °C